



30 years of designing and manufacturing innovative electric fencing solutions

NEMTEK
Electric Fencing Products



SECURITY

ELECTRIC FENCING PRODUCTS THAT DELIVER PEACE OF MIND



introduction

The Nemtek group is a globally known and well-respected company, manufacturing a full range of energizers and fencing hardware. With our pioneering products, we have become the benchmark for the security electric fencing industry and the products of choice for many governments, local authorities and industries to protect defence infrastructures, correctional facilities and utilities.

Our success has been achieved by:

- Our continuous innovation, resulting in unique, trailblazing and often patented products and technologies
- The reliability and efficiency of Nemtek products
- Our fast response to the ever-changing market and customer needs
- Our unparalleled customer service and the continuous support and close working relationships we foster with our customers

This brochure offers you an overview of the electric fencing products that we design and manufacture, including a comprehensive range of electric fencing energizers and a complete range of electric fencing hardware. We have products available that can reliably address many different types of fencing needs ranging from residential, retail, industrial and commercial, to airports, power stations, prisons, defence facilities and other utilities.

Our unbeatable experience in the security field has revolutionised the design of game and animal farm energizers. These energizers now offer security features and communication capabilities, to not only keep animals in, but to also effectively combat the theft and injury of animals by poachers and predators.

For more details and information on our products, visit www.nemtek.com.

NEMTEK™ FAMOUS BRANDS

- Druid™ energizers
- Wizord™ energizers
- Merlin Stealth™ energizers
- FenceScope™ fence tool
- Dual Action Tensor Sensor (DATS)
- Perimeter light
- Adaptive Power Technology (APT™)
- Nemtek Animal Management
- Omega brackets
- Modulus brackets
- Nemtek Connect
- Tension Sensor

PATENTS:

Nemtek's innovative culture has resulted in our company filing for many patents and trademarks around the world to protect our intellectual property and inventive spirit.

NEMTEK SERVICE SUPPORT AND TRAINING

Nemtek offers support and advice for customers' security needs, including expert advice on the design of your fence and choice of hardware and electronics.

The Nemtek Training Academy also offers fully accredited training courses, including COC accreditation at select branches and online. International training is also available online or through our Nemtek partners around the world. For any advice, enquires or training information please email websales@nemtek.com.



residential

Homeowners trust Nemtek products to provide security for everything they value most. Our extensive range of electrified fencing security products has helped ensure the safety and well-being of households for over 30 years. Nemtek products are trusted and recommended by many homeowners to offer better security for their families and friends. The continually evolving and inventive Nemtek range offers innovative solutions for any residential application, with numerous choices to ensure that homes are secure without compromising on aesthetics.

commercial

Whether you need to secure car and boat showrooms, office and commercial parks, caravan, car and motor home displays, outdoor showrooms, or retail complexes, Nemtek has advanced security solutions for commercial applications that do the job. We have identified this need for secure perimeter protection combined with aesthetically pleasing designs that do not compromise on the effectiveness and the performance of the electric fence.

Solar farms, oil refineries, steel industries and mining sites often need to be protected from intruders, both from a safety and a security point of view. The need to protect large industrial areas has been met by Nemtek's range of full height fencing solutions. Nemtek systems can be added onto existing fences (piggyback) or can be completely freestanding where no fence exists. In many instances, multiple fence zones are required and the modular design of Nemtek energizers makes this easy to achieve.



infrastructure

Government facilities and critical infrastructures need to be protected. Power distribution facilities, water reservoirs, transport depots, pumping stations and gas pipelines are some of the types of utilities that often need to be protected, as disruptions or interferences can cause large-scale implications for governments, cities and the community as a whole. Protection is often required to prevent harm to individuals by stopping them from gaining access to sensitive or dangerous areas such as train depots or even electrical transformers and electrical distribution areas. The Nemtek range of hardware, software and energizer design will ensure that a reliable security solution is available for these infrastructures.

Nemtek manufactures all its products with high security in mind, and our range of products can be integrated with other technologies such as cameras. High-security sites can also be remotely accessed and monitored with the Nemtek solutions. Our vast experience in these types of sites in many different parts of the world have made Nemtek a trusted source for products and knowledge to address most high-security needs. These sites include prisons, airports, naval bases, border fences, embassies, mints and money distribution points.





REASONS FOR USING AN ELECTRIC FENCE

- 1 DETECT
- 2 DETER
- 3 DELAY

When a physical barrier, such as a wall or a fence, is combined with an electric fence it will deter attempts to infiltrate the protected perimeter. The electric fence delivers a high-voltage shock that is non-lethal but memorable to the potential intruder. The Nemtek electric fence energizer has a detecting feature which produces an alarm when the protected perimeter has been breached or tampered with. By using an electric fence, the attempted break-in of the protected area can be delayed, giving additional time for a reaction team to respond to the breach.

contents

ENERGIZERS	6	FENCE WIRE, CABLE AND ACCESSORIES	36
ENERGIZERS: SINGLE ZONE		FENCE WIRES	
ENERGIZERS: SINGLE ZONE WITH LCD DISPLAY		HT CABLES	
ENERGIZERS: DUAL ZONE		WIRE TENSIONING SYSTEMS	38
ENERGIZERS: DUAL AND FOUR ZONE WITH LCD DISPLAY		WIRE TENSIONERS – PLASTIC	
FENCE CONTROLLERS		WIRE TENSIONERS – METAL	
SMART CARD CONTROLLER		TENSIONER AND INSULATOR HOOKS	
ENERGIZER SPECIFICATIONS		WIRE AND CABLE CONNECTORS	
FENCE MONITOR		WIRE DISPENSERS	
NEMTEK CONNECT		INSULATORS	42
MULTIZONE AND SITE NETWORKING SYSTEMS		PORCELAIN INSULATORS	
COMMUNICATION CARDS		PLASTIC INSULATORS	
POWER SUPPLY PACK		GENERAL ACCESSORIES	44
ELECTRIC FENCE TESTERS	21	FENCE ACCESSORIES	
FENCE METER		EARTH SPIKES	
FENCESCOPE MULTI TOOL		EARTH LOOPS	
EASY FENCE TESTER		GATE SYSTEMS	
TENSION SENSORS	22	FENCING TOOLS	
DUAL ACTION TENSION SENSOR		SOLAR POWER	47
TENSION SENSOR SYSTEM		SOLAR PANELS	
PERIMETER ALARM LIGHT SYSTEM	25	SOLAR REGULATOR	
BRACKETS AND ACCESSORIES	26	MOUNTING BRACKET	
WALL TOP BRACKETS		BATTERIES AND BATTERY BOXES	48
WALL TOP BRACKET ACCESSORIES		BATTERIES	
FREE STANDING SYSTEM		BATTERY BOXES	
OMEGA BRACKETS		ENERGIZER ENCLOSURES	49
OMEGA BRACKET ACCESSORIES		ELECTRIC FENCE COMPONENT CHECKLIST	51
MODULUS SYSTEM		TIPS TO INCREASE YOUR SECURITY	53

GENERAL INFORMATION

WARRANTIES: At Nemtek, we stand behind the quality and reliability of our energizer electronics. All our energizers come with a two-year warranty, subject to our standard terms and conditions as set out on the Nemtek website.

COMPLIANCE: All Nemtek energizers conform to international electric fencing safety standards. To learn more please visit the energizer section on our website.

SPECIFICATIONS: While we strive to provide accurate and up-to-date product information, please note that specifications may change without prior notice. The information provided in this brochure is intended for general information and marketing purposes only.

TERMS AND CONDITIONS OF SALE: All sales of Nemtek products are subject to our standard terms and conditions of sale, as well as our distribution agreements. Our terms and conditions are available at all Nemtek branches.

AUTHORISED DISTRIBUTORS AND REPRESENTATIVE OFFICES: Nemtek has a global presence, with authorised distributors and representative offices worldwide. For further information or to find a distributor near you, please email us at websales@nemtek.com.

TRAINING COURSES: From the novice who wants to start doing installations, to the expert who wants to keep their skills sharp or be able to issue COCs after installations, we have a skills programme to fit your needs. We run monthly courses with options of classroom, online and virtual training – scheduled dates and venues are available on our website www.nemtek.com.

ENERGIZERS

ENERGIZERS: SINGLE ZONE

WIZORD

The Wizord energizers have been field tested for many years and boast unsurpassed reliability. Simple to install and easy to maintain.



SINGLE ZONE

2J OUTPUT

WIZORD 2i (E-WIZ2i)

- Built-in alarm monitors tampering or faults on the high voltage and earth fence wires
- Connectable to armed response radio or GSM module
- Lightning and power surge protection
- Intelligent power saving to extend battery life
- Easy-to-use tag included for controlling the energizer
- Powered by 230V mains and includes built-in battery for back-up power
- Built-in gate alarm input to monitor if the gate is open or closed

OPTIONAL ACCESSORIES:



Double Pole
Lightning Protection



Nemtek Connect



Enclosure



SINGLE ZONE

3.7J OUTPUT

WIZORD 4i (E-WIZ4i)

- Built-in alarm monitors tampering or faults on the high voltage and earth fence wires
- Connectable to armed response radio or GSM module
- Lightning and power surge protection
- Intelligent power saving to extend battery life
- Easy-to-use tag included for controlling the energizer
- Powered by 230V mains and includes built-in battery for back-up power
- Built-in gate alarm input to monitor if the gate is open or closed

OPTIONAL ACCESSORIES:



Double Pole
Lightning Protection



Nemtek Connect



Enclosure



MERLIN 4i

The Merlin 4i energizers have been field tested for many years and boast unsurpassed reliability. Simple to install and easy to maintain.



SINGLE ZONE

3.7J OUTPUT

MERLIN 4i WITH KEYPAD (E-MER4i)

- Built-in alarm monitors tampering or faults on the high voltage and earth fence wires
- Connectable to armed response radio or GSM module
- Lightning and power surge protection
- Intelligent power saving to extend battery life
- Powered by 230V mains and includes built-in battery for back-up power
- Built-in gate alarm input to monitor if the gate is open or closed
- Gate chime available to alert that the gate has been opened or closed
- The fence voltage outputs can be adjusted using the keypad
- The siren and gate outputs can be bypassed using the keypad
- The Merlin 4i includes a keypad (EE-MKP) for controlling and programming the energizer
- The energizer can be installed near the fence and the keypad can be located where it is most convenient for the user. This allows the user to control the energizer remotely, with up to four keypads. Fence voltage and siren and gate outputs can be adjusted and bypassed using the keypad

OPTIONAL ACCESSORIES:



Double Pole Lightning Protection



Nemtek Connect



Enclosure

MERLIN STEALTH SINGLE ZONE

The Merlin Stealth single zone energizers are a powerful range that can be used from residential to high-end security needs. These energizers can be controlled by a tag and/or a keypad and can be programmed to offer customised solutions.



SINGLE ZONE

7.6J OUTPUT

MERLIN STEALTH M18S (E-M18S/V1)

- Built-in alarm monitors tampering or faults on the high voltage and earth fence wires
- Connectable to armed response radio or GSM module
- Lightning and power surge protection
- Intelligent power saving to extend battery life
- Easy-to-use tag included for controlling the energizer
- Powered by 230V mains and includes built-in battery for back-up power
- Two built-in gate alarm inputs to monitor if the gates are open or closed
- Optional single zone two gate keypad (EE-M1Z2GK) for controlling and programming the energizer. This allows the user to control the energizer remotely, with up to four keypads. Fence voltage and siren and gate outputs can be adjusted and bypassed using the keypad

OPTIONAL ACCESSORIES:



Double Pole Lightning Protection



Merlin Stealth Single Zone Two Gate Keypad



Enclosure



ENERGIZERS: SINGLE ZONE WITH LCD DISPLAY

DRUID

The LCD display in the Druid range makes information on the status and performance of the energizer quick and easy to read. Using the Adaptive Power Technology (APT) pioneered by Nemtek, these energizers offer a unique technology to detect how much power a fence can accept and handle before it starts to arc and waste energy. This maximises the power on the fence and minimises false alarms.



SINGLE ZONE

3J OUTPUT

APT

DRUID 13LCD (E-DRUID/13/LCD)



- Built-in alarm monitors tampering or faults on the high voltage and earth fence wires
- Connectable to armed response radio or GSM module
- Lightning and power surge protection
- Intelligent power saving to extend battery life
- Easy-to-use tag included for controlling the energizer
- Walk test mode for easy fence testing
- The LCD background changes colour to help identify the fence condition
- Powered by 230V mains and includes built-in battery for back-up power
- Built-in gate alarm inputs to monitor if the gates are open or closed
- Optional single zone keypad (EE-DR.LCD/KP) for controlling and programming the energizer. This allows the user to control the energizer remotely, with up to two keypads. Fence voltage and siren and gate outputs can be adjusted and bypassed using the keypad

OPTIONAL ACCESSORIES:



Double Pole
Lightning Protection



Nemtek Connect



Druid Single Zone
Keypad





Enclosure



SINGLE ZONE

4.6J OUTPUT

APT

DRUID 15LCD (E-DRUID/15/LCD)  

- Built-in alarm monitors tampering or faults on the high voltage and earth fence wires
- Connectable to armed response radio or GSM module
- Lightning and power surge protection
- Intelligent power saving to extend battery life
- Easy-to-use tag included for controlling the energizer
- Walk test mode for easy fence testing
- The LCD background changes colour to help identify the fence condition
- Powered by 230V mains and includes built-in battery for back-up power
- Built-in gate alarm input to monitor if the gates are open or closed
- Optional single zone keypad (EE-DR.LCD/KP) for controlling and programming the energizer. This allows the user to control the energizer remotely, with up to two keypads. Fence voltage and siren and gate outputs can be adjusted and bypassed using the keypad

OPTIONAL ACCESSORIES:



Double Pole Lightning Protection



Nemtek Connect

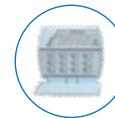

Druid Single Zone Keypad





Enclosure



SINGLE ZONE

7.6J OUTPUT

APT

DRUID 18LCD (E-DRUID/18/LCD)   

- Ideal choice for long distance series electric fencing systems that require monitoring
- Built-in alarm monitors tampering or faults on the high voltage and earth fence wires
- Connectable to armed response radio or GSM module
- Lightning and power surge protection
- Intelligent power saving to extend battery life
- Easy-to-use tag included for controlling the energizer
- Walk test mode for easy fence testing
- The LCD background changes colour to help identify the fence condition
- Powered by 230V mains and includes built-in battery for back-up power
- Built-in gate alarm input to monitor if the gates are open or closed
- Optional single zone keypad (EE-DR.LCD/KP) for controlling and programming the energizer. This allows the user to control the energizer remotely, with up to two keypads. Fence voltage and siren and gate outputs can be adjusted and bypassed using the keypad

OPTIONAL ACCESSORIES:



Double Pole Lightning Protection



Nemtek Connect



Druid Single Zone Keypad



Enclosure

ENERGIZERS: DUAL ZONE

MERLIN STEALTH DUAL ZONE

The Merlin Stealth dual zone energizers are a powerful range that can be used from residential to high-end security needs and is a cost-effective solution where more than one zone is required. Separation of the fence into zones allows easy identification of the zone affected by fence faults or tampering. Smart design allows the maximum amount of energy to be transferred to the zone that needs it, yet the combined energy of the two zones will not exceed the legal maximum permitted. These energizers can be controlled by a tag and/or a keypad and can be programmed to offer customised solutions.



TWO
ZONE

7.6J
OUTPUT

MERLIN STEALTH M28S (E-M28S/V1)



- Built-in alarm monitors tampering or faults on the high voltage and earth fence wires
- Connectable to armed response radio or GSM module
- Lightning and power surge protection
- Intelligent power saving to extend battery life
- Easy-to-use tag included for controlling the energizer
- Powered by 230V mains and includes built-in battery for back-up power
- Two built-in gate alarm inputs to monitor if the gates are open or closed
- Optional dual zone two gate keypad (EE-M2ZKP) for controlling and programming the energizer. This allows the user to control the energizer remotely, with up to four keypads. Fence voltage and siren and gate outputs can be adjusted and bypassed using the keypad

OPTIONAL ACCESSORIES:



Double Pole
Lightning Protection



Merlin Dual Zone
Two Gate Keypad

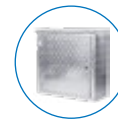

Enclosure



ENERGIZERS: DUAL AND FOUR ZONE WITH LCD DISPLAY

DRUID

The LCD display in the Druid range makes information on the status and performance of the energizer quick and easy to read. Using the Adaptive Power Technology (APT) pioneered by Nemtek, these energizers offer a unique technology to detect how much power a fence can accept and handle before it starts to arc and waste energy. This maximises the power on the fence and minimises false alarms. Synchronisation between energizers can be achieved by using traditional network cabling or by using the Druid synchronisation modules which use orbiting satellites eliminating the need for cabling between the energizers.



2 & 4
ZONE

2 x
2.4J
OUTPUT

APT

ALARM
SENSOR
MODE

NET-
WORK

SYNCHRO-
NISE

DRUID 25LCD (E-DRUID/25/LCD)



- Two independently monitored and controlled zones
- Each zone can be set independently to be on/off or in high/low voltage modes
- Can be programmed into alarm sensor mode allowing it to be integrated into a separate burglar alarm system
- Four zones can easily be created by linking two Druid 25LCD energizers together using the Druid four zone keypad (EE.DR/KP/4Z)
- Built-in alarm monitors tampering or faults on the high voltage and earth fence wires
- Connectable to armed response radio or GSM module
- Lightning and power surge protection
- Intelligent power saving to extend battery life
- Easy-to-use tag included for controlling the energizer
- Powered by 230V mains and includes a built-in battery for back-up power
- Built-in gate alarm input to monitor if the gate is open or closed
- The Relay Expansion card can be used to increase the number of information inputs and outputs from the energizer
- Walk test mode for easy fence testing
- The LCD background changes colour to help identify the fence condition
- Optional dual zone (EE-DR.LCD/KP/2Z) and four zone (EE-DR.LCD/KP/4Z) keypads for controlling and programming the energizer. This allows the user to control the energizer remotely, with up to two keypads

OPTIONAL ACCESSORIES:



Double Pole
Lightning Protection



Nemtek Connect



Druid Dual or Four
Zone Keypad



Enclosure



2 & 4
ZONE

2 x
3.7J
OUTPUT

APT

ALARM
SENSOR
MODE

NET-
WORK

SYNCHRO-
NISE

DRUID 28LCD (E-DRUID/28/LCD)



- Two independently monitored and controlled zones
- Each zone can be set independently to be on/off or in high/low voltage modes
- Can be programmed into alarm sensor mode allowing it to be integrated into a separate burglar alarm system
- Four zones can easily be created by linking two Druid 28LCD energizers together using the Druid four zone keypad (EE.DR/KP/4Z)
- Built-in alarm monitors tampering or faults on the high voltage and earth fence wires
- Connectable to armed response radio or GSM module
- Lightning and power surge protection
- Intelligent power saving to extend battery life
- Easy-to-use tag included for controlling the energizer
- Powered by 230V mains and includes a built-in battery for back-up power
- Built-in gate alarm input to monitor if the gate is open or closed
- The Relay Expansion card can be used to increase the number of information inputs and outputs from the energizer
- Walk test mode for easy fence testing
- The LCD background changes colour to help identify the fence condition
- Optional dual zone (EE.DR/KP/2Z) and four zone (EE.DR/KP/4Z) keypads for controlling and programming the energizer. This allows the user to control the energizer remotely, with up to two keypads. Fence voltage and siren and gate outputs can be adjusted and bypassed using the keypad

OPTIONAL ACCESSORIES:



Double Pole
Lightning Protection



Nemtek Connect

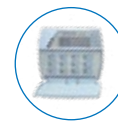

Druid Dual or Four
Zone Keypad

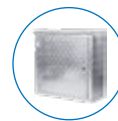

Enclosure



DRUID RELAY EXPANSION CARD (EE-LCD2X/REL)

- This expansion card can be used to increase the number of information inputs and outputs from the D25 and D28 energizers, and can be installed in the energizer housing
- It has four inputs which can be used to switch the individual zones on/off and to switch between high and low voltage for each zone
- It has ten relay outputs which can be used to indicate:
 - Mains failure
 - Battery low
 - Zone 1 and zone 2 alarms
 - Zone 1 and zone 2 check fence alarms
 - Service conditions
 - Tamper conditions
 - Communication timeouts



SYNCHRO-
NISE

DRUID SYNCHRONISATION MODULE (EE-LCD2X/GPSYNC)

Synchronisation between energizers has traditionally been done by physically connecting the energizers through wiring. The groundbreaking Nemtek synchronisation module synchronises the Druid dual zone energizers using satellites eliminating the need for wiring between energizers, saving on costs and making the installation quicker and easier.

- Easy to install and ready to use
- Watertight housing for external installation

FENCE CONTROLLERS

The Nemtek Druid controller FG7C LCD touch-screen controls up to 32 Nemtek Druid dual zone energizers and fence monitors and can also be integrated with the Nemtek fence probe software (E-NDFP01) or to a third-party security management system using the FG7C.

64
ZONE



DRUID CONTROLLER FG7C

- Up to 32 Druid dual zone energizers and fence monitors, providing up to 64 zones, can be controlled
- Up to 2 Nemtek network IO cards can be controlled
- Can be used in conjunction with multiple Smart IO relay cards
- Graphic image of the site with zones and the fence and energizer conditions can be displayed on the LCD screen
- Commands can be sent to the energizers using the touchpad
- Logs containing system details are recorded
- Allows for three different types of users with different access levels to be set up
- Can be configured to allow TCP/IP connectivity for integration with third-party software and systems
- For large-scale systems, additional FG7C controllers can be added together
- Available in wall mount (E-FG7C/DRUID/WM) and panel mount (E-FG7C/DRUID/PM) options
- Can be powered by a Nemtek Power Pack (PP-2.0AMP)



FG7C RS485 INTERNAL CARD (EE-FG7C/485/TW)

- RS485 communication card fits inside the FG7C controller
- Input included for the Tension Wire sensors (E-TWS1)



FG7C NEMLINK INTERNAL CARD + TENSION WIRE (EE-FG7C/NLE/TW)

- With ethernet communication card and fits inside the FG7C controller
- Input included for the Tension Wire sensors (E-TWS1)

SMART CARD CONTROLLER

The Smart IO card is typically used as an interface between a network containing Tension Sensor Wire Node 1 network controller, Druid 25LCD or Druid 28LCD energizer, and third-party systems, but is a general input-output device. The Smart IO card can also be configured to control a Druid Network IO Card 8+1.



SMART IO RELAY CARD (EE-PRI08/NL)

- 8 digital inputs
- Available in a RS485 version (EE-D/485/1)
- 8 programmable relay outputs and 1 good communication relay output
- Robust surge protection is included on all inputs and outputs
- All relays can be individually configured to be independent dry contacts or common-ground wet contacts with 12V nominal output
- Each relay has a very useful LED indicator to show if the relay is energized
- 3 communications debug LED indicators for Tx, Rx and Valid Command
- In addition to the input states, the IO card also reports on temperature and supply voltage levels
- Designed to mount into a Nemtek Power Pack (PP-2.0AMP)

ENERGIZER SPECIFICATIONS

Nemtek Energizer Brand	Wizord™		Merlin	Merlin Stealth™		Druid™				
Model Number	2i	4i	4i	M18S	M28S	13 LCD	15 LCD	18 LCD	25 LCD	28 LCD
Energizer Dimensions										
	L285 x W212 x D120			L370 x W232 x D145		L285 x W212 x D120		L370 x W232 x D145	L400 x W270 x D125	
High-Voltage Outputs										
Typical energy output into 500 Ohms load (Joules)	2J	3.7J	3.7J	7.6J	7.6J	3J	4.6J	7.6J	2 x 2.4J	2 x 3.7J
Output voltage into an open circuit	7 400V	8 000V	8 000V	9 300V	9 300V	9 000V	9 000V	9 600V	9 000V	9 000V
High or low voltage modes. Voltage settings can be set for both the high and the low voltage modes			Yes	Yes	Yes	Yes	Yes	Yes	Yes	Yes
Number of high-voltage monitored zones	1	1	1	1	2	1	1	1	2	2
Number of earth loop monitored zones	1	1	1	1	2	1	1	1	2	2
Adaptive Power Technology (APT)						Yes	Yes	Yes	Yes	Yes
Fence interference detection from foreign energizers		Yes	Yes			Yes	Yes	Yes	Yes	Yes
Energizer Controls and Displays										
Keypads for the remote control of the energizer	No	No	4 max 1 incl	4 max	4 max	2 max	2 max	2 max	2 max	2 max
Tag to control the energizer without using a keypad	Yes	Yes	Yes	Yes	Yes	Yes	Yes	Yes	Yes	Yes
Remote on/off input	Yes*	Yes*	Yes*	Yes*	Yes*	Yes*	Yes*	Yes*	Yes	Yes
Displays the output and return voltages						Yes	Yes	Yes	Yes	Yes
Display type	LED	LED	LED	LED	LED	LCD	LCD	LCD	LCD	LCD
Gate and Panic Button Inputs										
Timed gate switch input, used to monitor opening and closing of the gate	Yes*	Yes*	Yes*	Yes	Yes	Yes*	Yes*	Yes*	Yes	Yes
Panic button input	Yes*	Yes*	Yes*	Yes*	Yes*	Yes*	Yes*	Yes*	Yes	Yes
Alarm Outputs										
Siren output, time programmable	Fixed	Fixed	Yes	Yes	Yes	Yes	Yes	Yes	Yes	Yes
Strobe light output to visually indicate an alarm condition	1	1	1	1	2	1	1	1	2	2
Power Supply and Battery Back-up Systems										
Mains supply voltage***	230V	230V	230V	230V	230V	230V	230V	230V	230V	230V
Typical power consumption under normal operating conditions	17VA	18VA	16VA	27VA	27VA	18VA	18VA	25VA	18VA	23VA
Internal battery back-up system in case of power failure, capacity of battery	7Ah	7Ah	7Ah	7Ah	7Ah	7Ah	7Ah	7Ah	7Ah	7Ah
Typical standby time, with a fully-charged battery	24 hrs	24 hrs	24 hrs	8 hrs	6 hrs	24 hrs	24 hrs	24 hrs	24 hrs	24 hrs
Solar voltage regulator	5Amp	5Amp	5Amp	15Amp	15Amp	5Amp	10Amp	15Amp	10Amp	15Amp
Solar power panels can be connected to power the energizers, (recommended Watt size for 24-hour operation)**	60 Watts	60 Watts	60 Watts	140 Watts	140 Watts	60 Watts	90 Watts	140 Watts	90 Watts	140 Watts
Deep cycle battery size recommended in Amp hours (25% discharge over a 24-hour cycle)	60Ah	60Ah	60Ah	150Ah	150Ah	60Ah	100Ah	150Ah	100Ah	150Ah

Nemtek Energizer Brand	Wizord™		Merlin	Merlin Stealth™		Druid™				
Model Number	2i	4i	4i	M18S	M28S	13 LCD	15 LCD	18 LCD	25 LCD	28 LCD
Wire Length per Energizer (Live Wires in a Series System) for Both Solid and Stranded Wires										
Galvanised wires, 1.2mm										
• Optimal performance up to	2km	3km	3km	10km	2 x 5km	3km	5km	10km	2 x 2.5km	2 x 3km
• Maximum	4km	5km	5km	25km	2 x 13km	5km	8km	25km	2 x 4km	2 x 6km
Galvanised, XL and Galfan wires, 1.6mm										
• Optimal performance up to	2km	3km	3km	14km	2 x 7km	3km	5km	12km	2 x 2.5km	2 x 3km
• Maximum	4km	6km	6km	28km	2 x 15km	5km	8km	24km	2 x 4km	2 x 6km
Galvanised, XL and Galfan wires, 2.0mm										
• Optimal performance up to	2.5km	3.5km	3.5km	16km	2 x 8km	3.3km	5.5km	14km	2 x 2.8km	2 x 3.5km
• Maximum	5km	7km	7km	30km	2 x 15km	5.6km	9km	28km	2 x 5km	2 x 7km
Galvanised wires, 2.24mm										
• Optimal performance up to	3km	4km	4km	20km	2 x 10km	3.8km	6km	20km	2 x 3km	2 x 4km
• Maximum	6km	10km	10km	50km	2 x 25km	6.6km	10km	50km	2 x 6km	2 x 10km
Stainless steel 1.0mm, 304 and 316 grade										
• Optimal performance up to	0.5km	0.6km	0.6km	0.7km	2 x 0.8km	0.6km	0.7km	0.8km	2 x 0.6km	2 x 0.7km
• Maximum	0.6km	0.9km	0.9km	1km	2 x 1.2km	0.9km	1km	1km	2 x 0.9km	2 x 1.1km
Stainless steel 1.2mm, 304 and 316 grade										
• Optimal performance up to	0.6km	0.7km	0.7km	1km	2 x 1km	0.7km	0.8km	1km	2 x 0.7km	2 x 0.9km
• Maximum	0.9km	1km	1km	1.3km	2 x 1.3km	1km	1.1km	1.3km	2 x 1km	2 x 1.2km
Stainless steel 1.6mm, 316 grade										
• Optimal performance up to	1.2km	1.4km	1.4km	2km	2 x 2km	1.4km	1.6km	2km	2 x 1.5km	2 x 1.9km
• Maximum	1.8km	2km	2km	2.6km	2 x 2.6km	2km	2.2km	2.6km	2 x 2.1km	2 x 2.5km
Stainless steel 2.0mm, 316 grade										
• Optimal performance up to	1.8km	2.1km	2.1km	3.3km	2 x 3km	2.1km	2.4km	3.3km	2 x 2.3km	2 x 2.9km
• Maximum	2.7km	3km	3km	3.9km	2 x 3.9km	3km	3.3km	3.9km	2 x 3.2km	2 x 3.8km
Aluminium wire 1.6mm and 2.0mm										
• Optimal performance up to	6km	8km	8km	40km	2 x 20km	8km	10km	40km	2 x 6km	2 x 8km
• Maximum	12km	16km	16km	80km	2 x 40km	16km	20km	80km	2 x 12km	2 x 16km
Aluminium wire 2.5mm										
• Optimal performance up to	6km	8km	8km	40km	2 x 20km	8km	10km	40km	2 x 6km	2 x 8km
• Maximum	12km	16km	16km	80km	2 x 40km	16km	20km	80km	2 x 12km	2 x 16km
Multi-Energizer Systems										
Can be used in multi-energizer network system									Yes	Yes
Compliance										
IEC 60335-2-76 CISPR 14, EN 61000	Yes	Yes	Yes	Yes	Yes	Yes	Yes	Yes	Yes	Yes

Output energy is a function of component tolerance and energy settings and is reduced during power failure.

YES* Indicates that this function is available at the cost of another function, further details are on our website www.nemtek.com.

** Solar panel sizes and battery capacities are based on the exposure to sunlight in southern Africa and can change depending on the location of the solar panels.

*** All energizers are manufactured with a 230Vac ± 10% transformer, 110 Volts are available on request. Batteries are supplied as a standard.

Specification may change without prior notice.



FENCE MONITOR

Fence Alarm Monitors are used to monitor fences in public areas or areas where an electric fence would be a legal concern, like a playground. The unit uses a pulse below 50V which means that animals or people touching the fence will not receive a shock, making it safe.



DRUID 20LCD FENCE MONITOR (E-DRUID/20FM/V1)

- Monitors for continuity using safe 50V pulses
- Can work in conjunction with other energizers
- The robust and flexible design is ideal for residential, commercial, industrial and high security sites
- Four zones can easily be created by linking two D20 fence monitors together using the Druid four zone keypad
- Optional dual keypad (EE-DR.LCD/KP/2Z) for controlling and programming the low voltage fence monitor
- Detects an open circuit or short
- Ensures the fence is safe to be used in public access areas
- Connectable to armed response radio or GSM module
- Lightning and power surge protection
- Intelligent power saving to extend battery life
- The LCD background colour changes to easily identify the fence condition
- Can be tested using the Druid 20LCD Fence Monitor Tester (TL-FM/D20)



DRUID 20LCD FENCE MONITOR TESTER (TL-FM/D20)

- The Druid 20LCD Fence Monitor Tester helps diagnose problems on your low voltage fence to optimise the fence installation and ensure that the fence operates at an ideal level
- Patented fence probe offers more accurate readings
- Quickly and easily locates faults along the fence line
- Large display for easy reading
- Lightweight with a convenient belt clip
- Slimline, rugged design with a water-resistant case
- Low battery warning
- Optional pouch (TL-FMTP)

NEMTEK CONNECT

Control and monitor your energizer from anywhere with Nemtek Connect and have added peace of mind on the status of your electric fence.

Nemtek Connect is a mobile application designed to remotely monitor and control Nemtek security electric fence energizers equipped with GSM cellular connectivity from anywhere and at any time. It allows users access to real-time information about the energizer's status, receive real-time alerts, as well as customising the system to their unique needs – all providing increased security and efficiency in managing the security of the electric fence. Whether you need to secure a small residential property, or a large commercial fence, Nemtek Connect provides you with an easy-to-use advanced, flexible and reliable security management solution that ensures the ongoing safety of your property.

The benefits of using Nemtek Connect on Nemtek energizers vary according to module of energizer and can include:

- Remote monitoring and control of the electric fence system, providing increased security and peace of mind
- Access to real-time information about the energizer, including status updates and fault alerts
- The ability to customise the energizer's settings, such as adjusting the pulse rate and voltage, to suit specific security needs
- Increased efficiency in managing electric fence security, reducing the need for physical checks and maintenance
- Nemtek Connect offers different user levels, ranging from an owner who has complete control of the system to a basic user who has limited access. This allows for flexible and secure management of the electric fence system

The following Nemtek electric fence energizers with GSM cellular connectivity enabled are supported:

- Wizord 2i
- Wizord 4i
- Merlin 4i
- Druid 13LCD
- Druid 15LCD
- Druid 18LCD
- Druid 114
- Druid 25LCD
- Druid 28LCD

Nemtek Connect works by connecting to a Nemtek electric fence energizer with GSM cellular connectivity via a GSM module and can be downloaded from the App Store or Google Play.



Simply search for **Nemtek Connect**

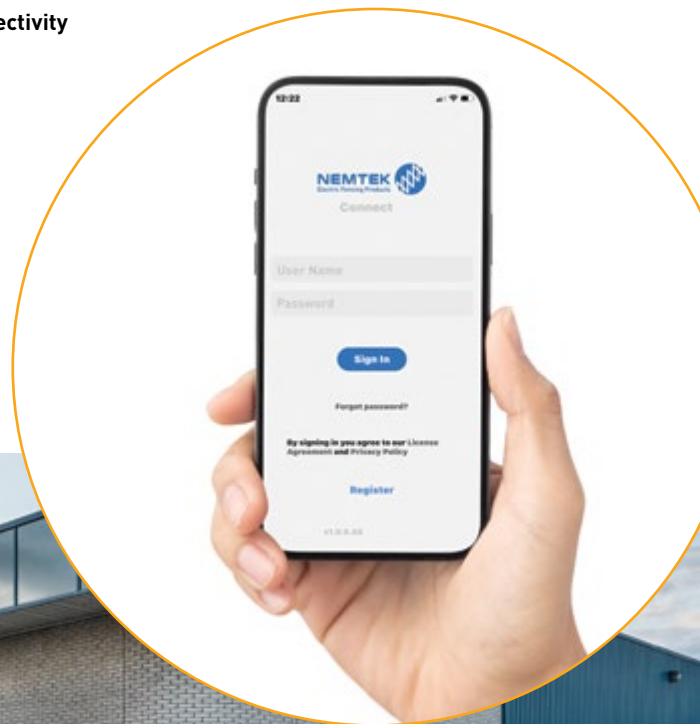

Please note that features available depend on model of energizer. The Druid 25LCD and the Druid 28LCD have all the features available. Not all countries supported. Contact websales@nemtek.com to check.



MULTIZONE AND SITE NETWORKING SYSTEMS



NEMTEK FENCE PROBE SOFTWARE (E-NDFP01)

Nemtek Fence probe Software provides a PC-based visual interaction with your electric fence, fence monitors, tension sensor systems and network IO card systems. Visual map images of the electric fence system and its individual zones can be displayed on the computer screen, making remote monitoring and managing the site's perimeter security easier.

FEATURES:

- **Support for Multiple Devices:** The software is compatible with multiple FG7 controllers, with each controller able to monitor 32 dual-zone Druid LCD energizers, fence monitors, and up to 31 network cards. This allows for comprehensive management of a complex electric fence setup.
- **Site and Zone Control:** The software supports the management of multiple sites and zones. This feature helps ensure more controlled access to smaller areas within the larger site.
- **IO Communication Cards:** The software supports multiple IO cards, allowing physical connections between the electric fence system and other devices. For example, a zone going off could trigger a light to come on.
- **Event Logging:** The software logs all events and history related to the fence system, providing a record of activities and potential security incidents.
- **PC-Based Visual Interaction:** The software provides a graphical interface on a computer screen, allowing users to visually interact with their electric fence system, including fence monitors, tension sensor systems, and network IO card systems.

THIRD-PARTY INTEGRATION SOFTWARE

The FG7C also integrates with third-party software to trigger accessories like cameras, gates, and lights. This integration expands the software's functionality and gives users a more comprehensive and interconnected security and access control solution.

If you're interested in learning more about third-party integration options or need specific information about integrating this software in your country, the email address provided (websales@nemtek.com) can be used to contact Nemtek for further details.

SITE 1

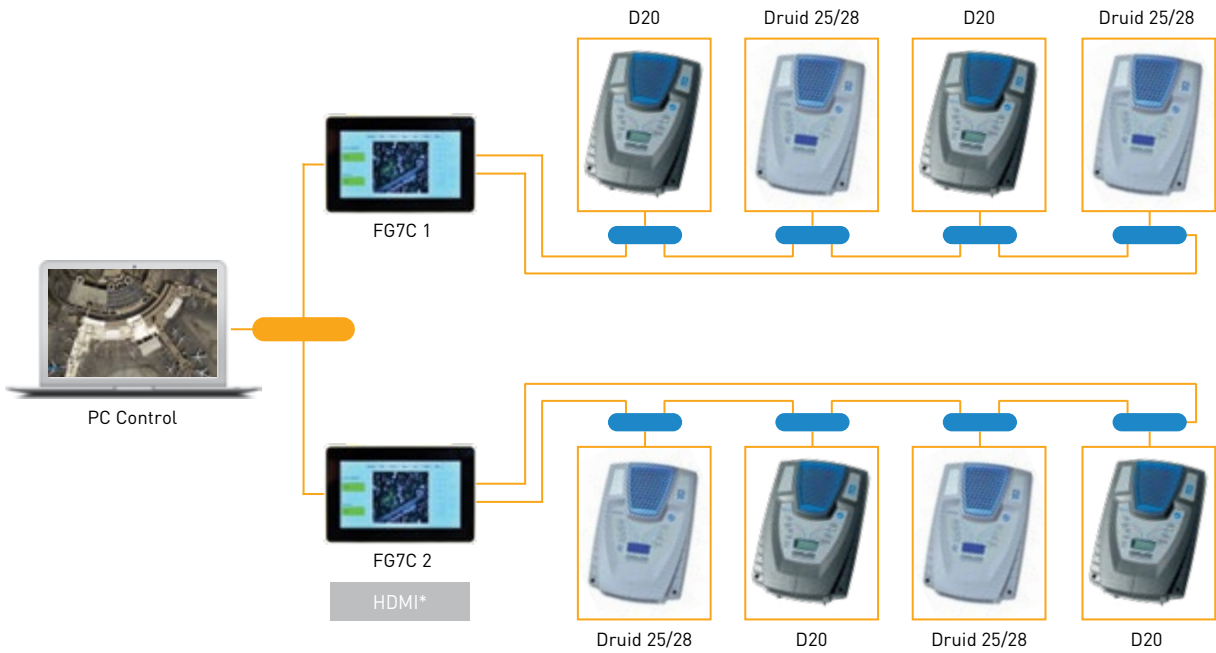

SITE 2

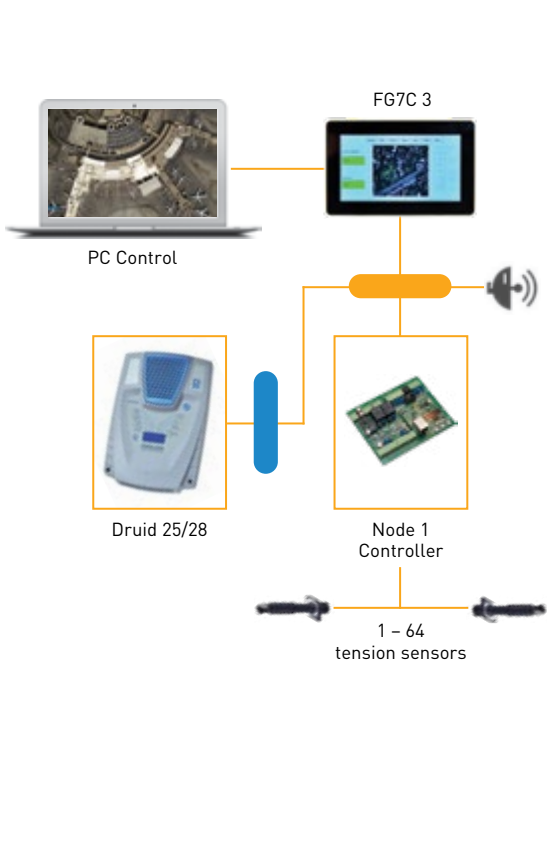

SITE 3

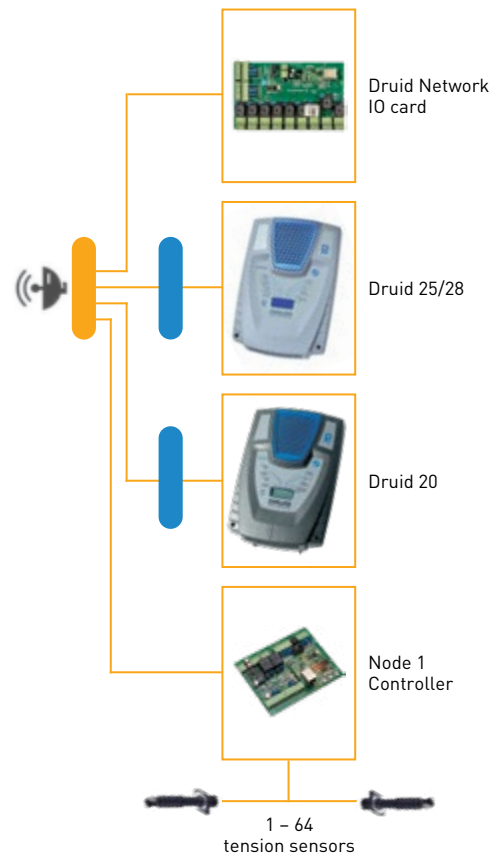

Communication cards Network switch Microwave link

* When using HDMI the FG7C screen is disabled.

COMMUNICATION CARDS



DRUID NEMLINK CARD

(EE-LCD2X/NLE)

- Communication card for linking the Druid 20, 25 and 28 to an RJ45 ethernet port
- For networking of the Druid 20, 25 and 28 and FG7C over a local area network (LAN)
- Fits inside the Druid 20, 25 and 28 housing



DRUID RS485 CARD

(EE-D/485/1)

- RS485 communication card
- Fits inside the Druid 20, 25 and 28 housing
- For communication and synchronisation over a star or daisy-chain RS485 network



DRUID NETWORK IO CARD

(EE-FG108/NL)

- Programmable network IO card
- Eight relay outputs with LED indication, individually set for potential free contacts or 12V output
- Eight inputs with individually selectable pull-ups



DRUID NEMLINK CARD – NETWORK IO

(EE-LCD2X/NLI0)

- Communication card for linking the Druid Network IO card (EE-FG108/485) to an RJ45 ethernet port
- For networking an IO card to the FG7C over a local area network (LAN)

Special precautions should be taken when connecting any network to an electric fencing system. These networks will be exposed to a greater risk from lightning damage. To minimise this increased risk, use a separate network for the electric fencing system or use galvanic isolation to separate the two networks.

POWER SUPPLY PACK

Use a Power Pack with energizers for longer life, powering up the FG7C, powering up a Node controller for Tension Sensor systems, powering up the Power Supply Module for Perimeter Alarm Lights, and powering up the Smart IO relay card.

POWER PACK 2AMP

(PP-2.0AMP)

- 2Amp power supply with a 7AH battery included
- Lightning and power surge protection
- The power pack can house the following:
 - Power Supply Trigger module (SR-FL/24PCB)
 - Druid Network IO card (EE-FG108/NL)
 - Smart IO relay card (EE-PR108/NL)
 - Node Controller (E-TW/NODE1, E-TW/NODE2)



POWER PACK WITH:



Node 2 Controller



Light PCB Power Supply Trigger Module



Smart IO Relay Card

ELECTRIC FENCE TESTERS



FENCE METER (TL-FM)

The Nemtek Fence Meter helps diagnose problems on your fence to optimise the electric fence installation and ensure that the fence operates at an ideal level.

FEATURES:

- Patented fence probe offers more accurate readings
- Quickly and easily locates faults along the fence line
- Large display for easy reading
- Displays current, voltage and direction of the fault
- Automatic energizer-polarity detection
- Lightweight with a convenient belt clip
- Slimline, rugged design with a water-resistant case
- Low battery warning
- Can be used with most energizers
- Optional pouch (TL-FMTP)



FENCESCOPE MULTI TOOL (TL-FS)

The FenceScope is a 4-in-1 tool that helps diagnose problems on your fence to optimise the electric fence installation and ensure that the fence continues to operate at ideal levels.

FEATURES:

There are four operation modes to select from:

- **Fence probe mode** – quickly indicates the direction of the fence fault, showing voltage and current
- **Fence energy mode** – accurately measures the output energy along the fence (tests the size of the shock the animal will receive at any point along the fence by simulating the animal)
- **Fence scope mode** – records and displays the waveforms of the electric fence pulse (distortions generally indicate the presence of fence faults)
- **Fence noise mode** – shows the amount of electromagnetic interference generated by the fence or energizer (assists in finding cracked or broken insulators, sparks and shorts along the fence)
- Optional pouch (TL-FSTP)

EASY FENCE TESTER (TL-EFT)

The frequency of the flashing LEDs will change as the voltage increases or decreases. The slower the flashing rate the lower the voltage. The intensity of the light remains the same so it can be seen from far irrespective of the fence voltage. It is installed between the earth and live wire to indicate the status and condition of the fence for peace of mind.

FEATURES:

- Includes clips to connect to wire or poly tape
- Indicates power on the fence
- Visible from up to 1km at night and 100m during the day
- No batteries required
- Uses minimal power from the fence
- Highly visible LEDs allow for a 160-degree viewing angle. This allows the light to shine into the secure area only
- Can operate from 0.9kV to 12kV
- Can be used with most electric fence energizers





TENSION SENSORS

DUAL ACTION TENSION SENSOR

The patented Nemtek Dual Action Tension Sensor – (DATS) can detect a change of tension in the fence wire. It uses the electric fence monitoring circuit to create an alarm condition on the energizer. The dual action increases the likelihood of an intruder being detected and reduces the possibility of tampering. The DATS2 is used with wire diameters up to 1.6mm for wall top applications and the DATS3 is for wire diameters up to 2.5mm for free standing fences.

DATS2 (TS-DATS2/XL, TS-DATS2/SS)



- Detection range (straight line) up to 50m
- Is paired with the Heavy-Duty Compression Spring Hybrid (ES-CNT2HB) so the tension in the fence wires can be adequately maintained (included)
- Detects a change in tension on a fence line
- Detects an open circuit at its first-stage trigger
- Detects a dead short at its second-stage trigger
- Constructed from robust material to suit all wire types up to 1.6mm
- There are two models available to cater for different wire types; TS-DATS2/XL is used with the galvanised and aluminium fence wires and the TS-DATS2/SS for the stainless steel wires
- Easy to install and retrofit onto most existing Nemtek electric fences

DATS3 (TS-DATS3/XL, TS-DATS3/SS)



- Detection range (straight line) up to 50m
- Is paired with the Heavy-Duty Compression Spring Hybrid (ES-CNT4HB) so the tension in the fence wires can be adequately maintained (sold separately)
- Detects a change in tension on a fence line
- Detects an open circuit at its first-stage trigger
- Detects a dead short at its second-stage trigger
- Constructed from robust material to suit all wire types up to 2.5mm
- There are two models available to cater for different wire types; TS-DATS3/XL is used with the galvanised and aluminium fence wires and the TS-DATS3/SS for the stainless steel wires
- Easy to install and retrofit onto most existing Nemtek electric fences

DATS BRIDGING WIRES

- Available in stainless steel finish 100mm (EA-DBW1.8X100SS) and 200mm (EA-DBW1.8X200SS)



TENSION SENSOR SYSTEM

The Nemtek tension sensor system measures tension changes on the fence wire and will set off an alarm if the wires are cut or if there is an attempt to part the wires in order to gain entry. Each sensor is placed in the middle of a straight run and can detect up to a 100m span of wire. The tension sensor system can be combined with an electric fence system creating a formidable detection and deterring barrier.

There are two types of controllers available to control the Nemtek tension sensors. The first is the FG7C tensor sensor controller which offers a visible display of the site and the sensors. The second type is the Node controller (Node 1 or Node 2) which interfaces with the tension sensors and can be controlled via a third-party platform such as an alarm system. The Node controllers can be used in conjunction with the Smart cards on a network for larger systems.



TENSION SENSOR CONTROLLER FG7C

- The tension sensor controller FG7C is a seven-inch LCD display screen that can be used to control up to 31 tension wire sensors and a network IO card
- Graphic images of the site with zones and the fence condition can be displayed on the LCD screen
- Commands can be sent to the tension wire sensors to configure them and adjust their sensitivity
- Logs containing system details are recorded
- Allows for three different types of user with different access levels to be set up
- Can be configured to allow TCP/IP connectivity for integration with third-party software and systems
- Available in panel mount (E-FG7C/TW/PM) and wall mount (E-FG7C/TW/WM) options

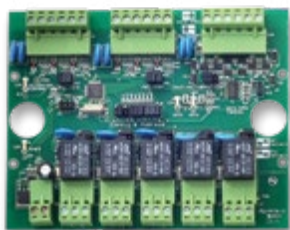

DRUID NETWORK IO CARD (EE-FGI05)

- Programmable network IO card with four relay outputs to create four zones and one global alarm output
- Relays individually set for potential free contact or 12V output
- Used with an FG7C controller



NODE 1 CONTROLLER (E-TW/NODE1)

The Tension Sensor Node 1 can communicate and interface with the Smart IO relay card through a network.

- Robust surge protection is included on all inputs and outputs
- 2 relay outputs
- 3 sets of communications debug LED indicators for Tx and Rx
- 1 power-on LED indicator
- Removable connectors ease replacement
- Designed to mount into a Nemtek Power Pack (PP-2.0AMP)
- Two separate sensor input channels – each capable of up to 31 tension sensors



NODE 2 CONTROLLER (E-TW/NODE2)

The Node 2 communicates and interfaces with third-party security systems through the two relays provided.

- Robust surge protection is included on all inputs and outputs
- 2 relay outputs
- 1 power-on LED indicator
- Monitoring of temperature and supply voltage levels can be reported on
- Removable connectors ease replacement
- Designed to mount into a Nemtek Power Pack (PP-2.0AMP)
- Two separate sensor input channels – each capable of up to 31 tension sensors



TENSION WIRE SENSOR (E-TWS1)

- The tension wire sensor can detect a rapid change of tension and send an alarm condition to the controller
- Built-in filter to reduce unwanted false alarms due to weather conditions and changes in tension over time
- Will notify the controller if an adjustment is required on the sensor
- Can be programmed from the controller
- UV stabilised polymers for outdoor use
- Stainless steel mountings and fasteners are included with the sensor



TENSION SENSOR DUMMY (E-TWS2)

- Used to reduce the cost of a system where not all wires need to be monitored
- Looks the same as a normal tension wire sensor
- UV stabilised polymers for outdoor use
- Stainless steel mountings and fasteners are included with the sensor

MYLAR SCREEN 3 CORE CABLE (CB-TWC/200)

- UV stabilised 200m roll of Mylar Screen 3 Core cable
- Communication cable to connect the sensors to the FG7C controller

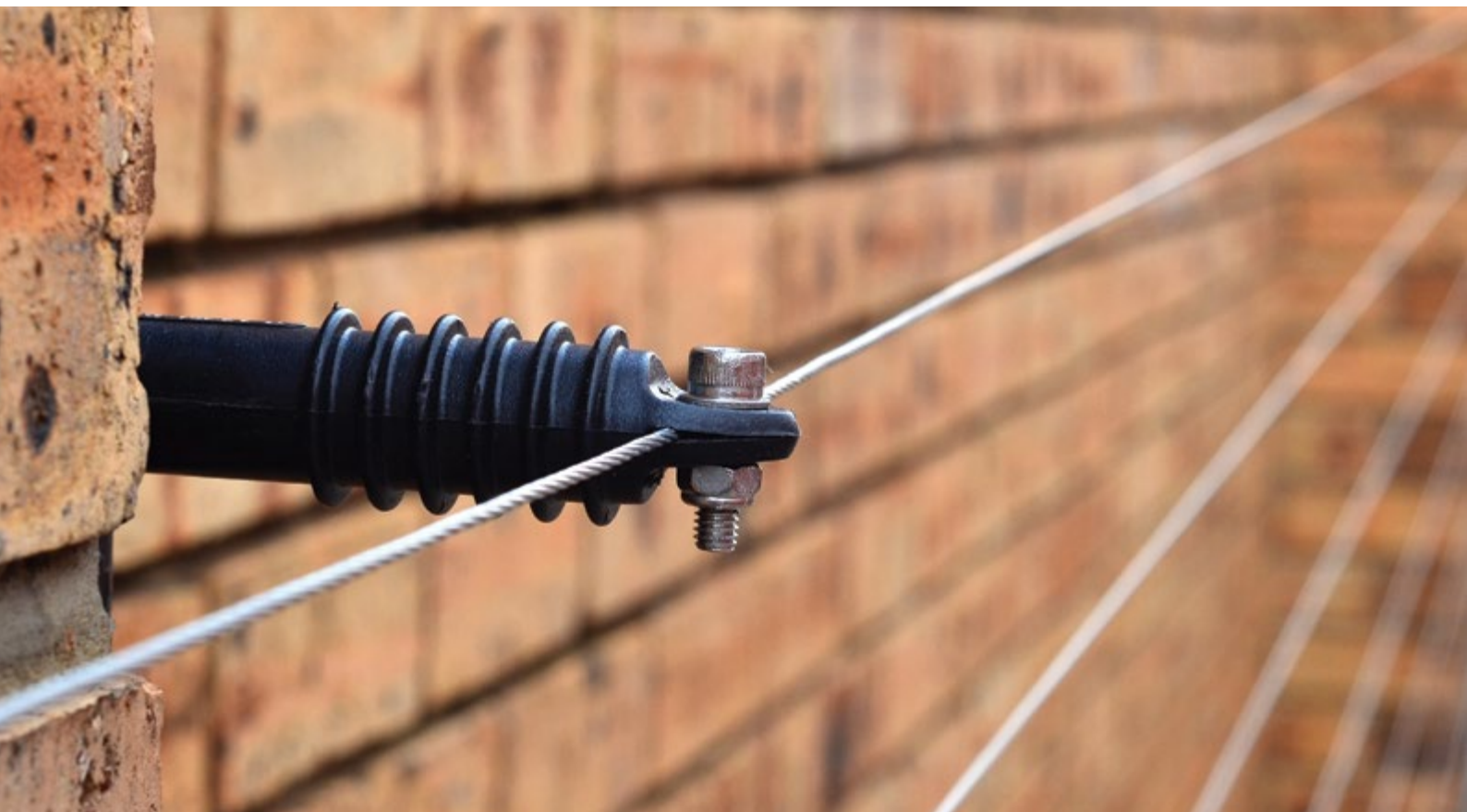

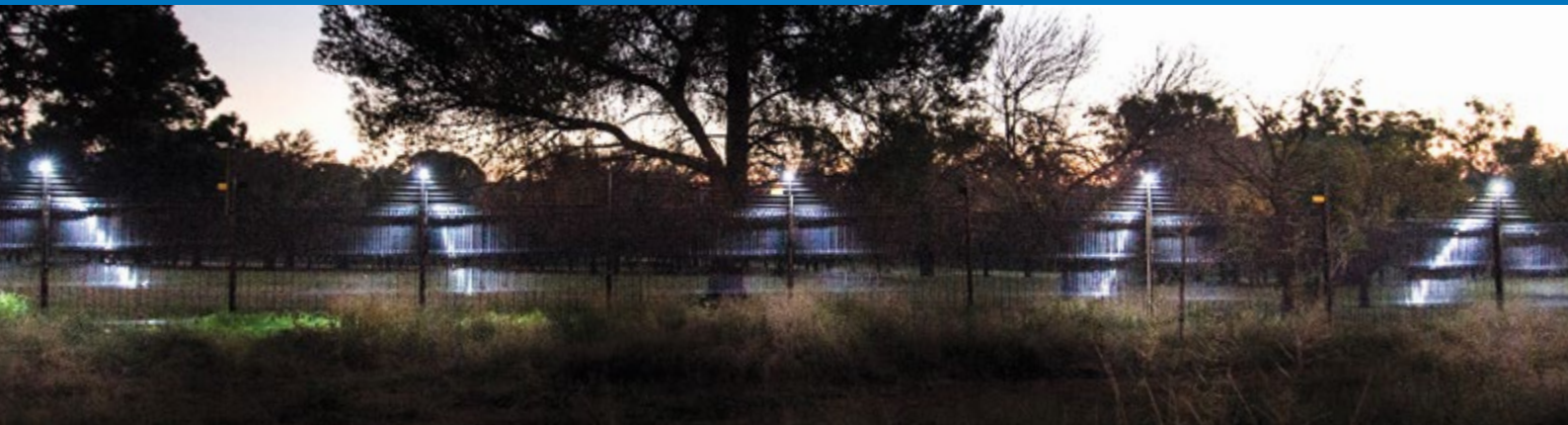

PERIMETER ALARM LIGHT SYSTEM

The perimeter alarm light system can be installed onto most of the Nemtek electric fencing brackets and posts. The lights are installed at 6m to 9m intervals along the electric fence line to illuminate the area. When the electric fence energizer alarms, the perimeter alarm lights will illuminate the specific zone that has been triggered. This could help detect and thus deter the intruder from attacking the fence line. The lights can also be triggered manually at any time using a remote control. The lights are LED, consuming low energy and will be illuminated immediately. They also face downward, thus minimising light pollution.



PERIMETER LIGHT CONTROL MODULE (SR-FL/24PCB)

- Power pack (PP-2.0AMP) required
- Input voltage 12VDC
- Maximum input current consumption 2A
- Output voltage 25.5V
- Maximum output current 800mA* at 25°C
- Maximum number of connected light modules 40 (20 sets)
- Trigger input voltage 10 – 30VDC**
- Maximum trigger input current consumption 1.5mA**
- Number of trigger inputs 3 (configurable as wet or dry contacts)
- Mounting 3 x 3mm holes***

* Over-current protected

** Jumpers configured for dry contact

*** Designed to mount inside a Nemtek Power Pack (PP-2.0AMP)



LIGHT MODULE 6 LED
(SR-FL/6LED)

DUAL LIGHT MODULE WITH MOUNTING BRACKET (SR-FL/DUAL)

- Lights are installed at 6m to 9m intervals along the fence line with 200m coverage on a power pack
- Lights are downward-facing
- Lights are LED so no warm-up time is required
- Lights can be triggered in three ways
 - Energizer alarm trigger
 - Remote on and off
 - Day/night switch
- Minimum luminous intensity 99 000mcd
- Emission colour Ultra-bright white
- Illumination angle 30°
- IP rating is IP67



LOW-VOLTAGE TWIN CABLE (CB-2CFLC)

- Low-voltage cabling is run along the fence line to provide power to the lights
- 100m roll

BRACKETS AND ACCESSORIES

WALL TOP BRACKETS

Nemtek wall top brackets are made to a high standard to maximise security and ensure long life in the field. The level of security achieved is directly affected by the choice of bracket, the number of wires forming the electrical barrier and the distance between the brackets. Nemtek offers a large range of brackets to suit most wall types and applications. They are made from steel and are finished in a high-quality outdoor powder coating, or are hot dip galvanised for coastal conditions. Our factory can manufacture different types of designs and finishes on request.

 <p>ROUND BAR</p> <ul style="list-style-type: none"> • 5, 6 or 8 wires • PC, HDG or HDG and PC finish • 600mm, 750mm or 1 000mm long 	 <p>FLAT BAR</p> <ul style="list-style-type: none"> • Straight or angled • 5 or 6 wires • PC, HDG or HDG and PC finish • 730mm or 830mm long 	 <p>SQUARE TUBE</p> <ul style="list-style-type: none"> • Straight or angled • 6, 8, 10 or 12 wires • PC finish • 995mm, 1 195mm, 1 395mm or 1 595mm long
 <p>SQUARE TUBE TOP BEND</p> <ul style="list-style-type: none"> • 6, 8 or 10 wires • PC finish • 995mm, 1 195mm or 1 395mm long 	 <p>SQUARE TUBE JURASSIC</p> <ul style="list-style-type: none"> • Straight or angled • 6, 8 or 10 wires • HDG or HDG and PC finish • 995mm, 1 195mm or 1 395mm long • Ideal for coastal use 	 <p>SQUARE TUBE JURASSIC TOP BEND</p> <ul style="list-style-type: none"> • 6 or 8 wires • HDG or HDG and PC finish • 995mm or 1 195mm long • Ideal for coastal use

PC: Powder coated finish in black or white. **HDG:** Hot dip galvanised. **HDG and PC:** First hot dip galvanised and then powder coated.

 <p>PROFILE POLE</p> <ul style="list-style-type: none"> • 6 wires • PC, HDG or HDG and PC finish • 385mm long 	 <p>T-POLE</p> <ul style="list-style-type: none"> • 6 wires • PC, HDG or HDG and PC finish • 600mm long 	 <p>SQUARE TUBE SHIELD T-POLE</p> <ul style="list-style-type: none"> • 8 wires • Offering high security • Large base plate for stronger mounting • PC or HDG finish • 760mm long • Option 2 allows for 10 lines with 2 insulators on the stem
 <p>SQUARE TUBE SHIELD WITH BASE</p> <ul style="list-style-type: none"> • 8 wires • Offering high security • Large base plate for stronger mounting • PC or HDG finish • 760mm long • Additional insulators can be added onto the back to create a 9 or 10 wire 	 <p>SQUARE TUBE SHIELD</p> <ul style="list-style-type: none"> • Straight and angled • 8 wires • Black PC finish • 1 195mm • Additional insulators can be added onto the back to create a 9 or 10 wire 	 <p>SQUARE TUBE SHIELD PIN</p> <ul style="list-style-type: none"> • Straight • 6 or 8 wires • HDG or HDG and PC • 695mm long • Additional insulators can be added onto the back to create a 7 or 8 wire



WALL TOP BRACKET ACCESSORIES



STAY AND LUG

- 600mm black PC (EST/L/B) and white (EST/L/W)
- 750mm black PC (EST/L/BL) and white (EST/L/WL)
- 600mm HDG (EST/L/HD)
- 750mm HDG (EST/L/HDL)
- 600mm is for flat bar and round bar brackets, 750mm is for 6 line and 8 line square tubing



STAY HEAVY DUTY

- 1 000mm black PC (ESTBL10) and white (ESTWL10)
- 1 000mm HDG (ESTHDL10)
- Used with the 10 wire and 12 wire square tube brackets



STAY SLEEVE

- UV stabilised insulator for the stays
- For 600mm stay black (ESTSSB) or white (ESTSSW)
- For 750mm stay black (ESTSLB) or white (ESTSLW)
- For 1 000mm stay black (ESTSLBL10) or white (ESTSLWL10)



LUGS

- Used with the stays and available for both the 8mm and 10mm stays
- For 8mm stay (EA-L635)
- For 8mm stay HDG (EA-L635/HDG)
- For 8mm stay Aluminium (EA-L635/ALU)
- For 10mm stay (EA-L670)



ROUND BAR STAY CLAMP

- (EA-RAT)
- Used in conjunction with the 8mm stay and lug to secure the stay on to the round bar











STAY AND SLEEVE KIT

- 10 x stay with lugs
- 10 x stay sleeves
- 10 x Nemtek lugs
- 10 x M6 x 30 Nut and Bolts
- Convenient, pre-assembled with stays available in hot dip galvanised 600mm (EST/HDKIT/B) or 750mm (EST/L/HDKIT/B) or black powder coated 600mm (EST/PCKIT/B) or 750mm (EST/L/PCKIT/B)





	<p>NAIL-IN ANCHORS</p> <ul style="list-style-type: none"> • 6mm x 40mm (100 box): ideal for inland use (EA-640) • 6mm x 60mm (100 box): ideal for inland use (EA-660) • 8mm x 80mm (50 box): ideal for inland use (EA-880) 	
	<p>HAMMER DRIVE ANCHORS</p> <ul style="list-style-type: none"> • Hammer drive with zinc alloy ideal for coastal use • 6mm x 50mm (100 pack) (EA-HDP650) • 6mm x 65mm (100 pack) (EA-HDP665) 	
	<p>COACH SCREW AND PLUG (EA-CSSET/HD)</p> <ul style="list-style-type: none"> • Hot dip galvanised for coastal use • Ideal for use with the Nemtek square tube brackets • 8mm x 75mm (50 pack) including wall plug and washer 	
	<p>TEK SCREWS – SELF DRILLING</p> <ul style="list-style-type: none"> • 12 x 25mm: inland and coastal use (EA-TEK12X25/HDG) • 12 x 38mm: inland and coastal use (EA-TEK12X38/HDG) • 12 x 65mm: inland and coastal use (EA-TEK12X65/HDG) • 14 x 75mm: inland and coastal use (EA-TEK14X75/DM) • 14 x 102mm: inland and coastal use (EA-TEK14X102/DM) 	

FREE STANDING SYSTEM

INTERMEDIATE POSTS

Nemtek has a range of products available to set up a free standing electric fence. These include corner and end posts for tensioning the fence and intermediate posts for guiding the wires between the posts.

INTERMEDIATE POSTS (Y-PICKETS)						
	Nemtek picket intermediate posts	Number of wires	Number of holes	Fence height	Finish	Associated insulators
	Nemtek Y-picket – 1.5m Bitumen (EY-Y15NB) Hot dip galvanised (EY-Y15NHD)	Up to 12	12 100mm spacing	1.2m	Bitumen or hot dip galvanised	Picket insulator (EI-PI) Popem insulator (EI-POPEM\B\ULT)
	Nemtek Y-picket – 2.4m Bitumen (EY-Y24NB) Hot dip galvanised (EY-Y24NHD)	Up to 20	20 100mm spacing	2.0m	Bitumen or hot dip galvanised	Picket insulator (EI-PI) Popem insulator (EI-POPEM\B\ULT)
	Nemtek Y-picket – 3.0m Bitumen (EY-Y30NB) Hot dip galvanised (EY-Y30NHD)	Up to 24	24 100mm spacing	2.4m	Bitumen or hot dip galvanised	Picket insulator (EI-PI) Popem insulator (EI-POPEM\B\ULT)

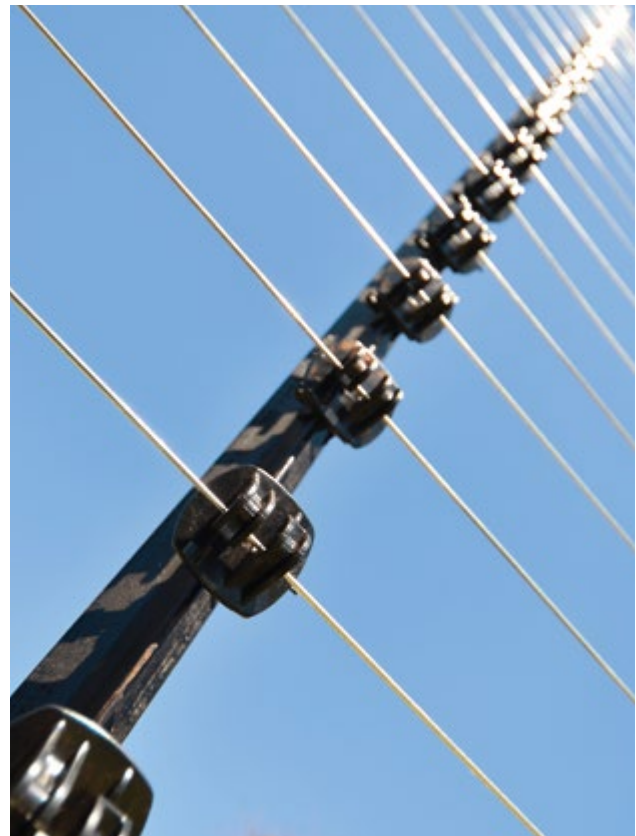

CORNER, END POSTS AND ASSOCIATED STAYS



CORNER, END POSTS AND ASSOCIATED STAYS						
	Round-corner and end-straining posts	Number of wires	Number of holes	Fence height	Finish	Associated stays
 <p>Nut (EA-SCRM10NUTSHD) Bolt (EA-SCRM10X120H)</p>	Round tube 76 x 2mm/1.5m (EY-CPR7620HD15)	12	2 x 12	1.2m	Hot dip galvanised	Round 38 x 2mm/1.5m (EY-CSR3815HD)
	Round tube 76 x 2mm/2.4m (EY-CPR7620HD24)	20	2 x 20	2.0m	Hot dip galvanised	Round 38 x 2mm/2.4m (EY-CSR3824HD)
	Round tube 76 x 2mm/3.0m (EY-CPR7620HD30)	24	2 x 24	2.4m	Hot dip galvanised	Round 50 x 2mm/3.0m (EY-CSR5030HD)
	Round tube 95 x 2mm/2.4m (EY-CPR9520HD24)	20	2 x 20	2.0m	Hot dip galvanised	Round 50 x 2mm/2.4m (EY-CSR5024HD)
	Round tube 95 x 2mm/3.0m (EY-CPR9520HD30)	24	2 x 24	2.4m	Hot dip galvanised	Round 50 x 2mm/3.0m (EY-CSR5030HD)

Black powder coated finish available to order



OMEGA BRACKETS

The Omega bracket is a versatile and flexible solution for use with an existing fence. The mechanical strength and structure of the existing fence is used to set up the electric fence. This reduces the time and cost of constructing a completely new fencing system. The pre-punched holes provide flexibility for the placement of the insulators.

FEATURES

- Available in pre-galvanised grade of mild steel for inland use
- Hot dip galvanised for coastal use where corrosion is high
- Available in pre-cut lengths, making it versatile and flexible where different lengths are required
- Lightweight and easy to transport reducing handling time and transport costs
- 2mm Omegas used for corners, end posts and gates where the bracket will be under stress of tensioning
- All 2mm Omega brackets are hot dip galvanised for coastal use
- All 1mm Omega intermediate posts are used to carry the wires



OMEGA BRACKET FINISH	OMEGA THICKNESS	OMEGA BRACKET – PRE-CUT SIZES (mm)						
		900mm	1 200mm	1 500mm	1 800mm	2 100mm	2 400mm	3 000mm
PRE-GALVANISED	1mm	EY-PR275/0900/1	EY-PR275/1200/1	EY-PR275/1500/1	EY-PR275/1800/1	EY-PR275/2100/1	EY-PR275/2400/1	EY-PR275/3000/1
HOT DIP GALVANISED	1mm	EY-PRHDIP0900/1	EY-PRHDIP1200/1	EY-PRHDIP1500/1	EY-PRHDIP1800/1	EY-PRHDIP2100/1	EY-PRHDIP2400/1	EY-PRHDIP3000/1
	2mm				EY-PRHDIP1800/2	EY-PRHDIP2100/2	EY-PRHDIP2400/2	EY-PRHDIP3000/2



OMEGA BRACKET ACCESSORIES

	<p>S-HOOK (ES-HK/EP)</p> <ul style="list-style-type: none"> • Suitable for end posts and gates • Hot dip galvanised finish 		<p>90 DEGREE S-HOOK (ES-HK/EP/90DEG)</p> <ul style="list-style-type: none"> • Suitable for corner posts • Hot dip galvanised finish
	<p>180 DEGREE S-HOOK (ES-HK/EP/DS)</p> <ul style="list-style-type: none"> • Suitable for splitting zones along straight runs • Hot dip galvanised finish 		<p>OMEGA PULL THROUGH ASSEMBLY (EI-BTL2, ES-HK/EP/PTH)</p> <ul style="list-style-type: none"> • Ideal for wire change of direction in inner corners • Quick and easy to install
	<p>OMEGA SPACER (EY-0/SWT)</p> <ul style="list-style-type: none"> • Used to offset the Omega bracket away from the fence or wall • Can be used on flat or round surfaces 		<p>OMEGA INSULATOR (EI-OB)</p> <ul style="list-style-type: none"> • Quick fit design • Double-tracking fin to reduce tracking and arcing • Available in collapsible version (EI-OB/C)
	<p>HEAVY DUTY COMPRESSION SPRING (ES-CNT3)</p> <ul style="list-style-type: none"> • Can be used with any type of electric fence wire • Can tension up to 2mm wire • Stainless steel spring maintains constant tension on the fence • Silver spring 		<p>HYBRID BB HEAVY DUTY NYLON TENSIONER (ES-CTNTBB)</p> <ul style="list-style-type: none"> • Can be used with any type of electric fence wire • Can tension from 1.2mm to 2.5mm wire, making it very versatile
	<p>HYBRID COMPRESSION SPRING 4 (ES-CNT4HB)</p> <ul style="list-style-type: none"> • Can be used with any type of electric fence wire • Can tension up to 2.24mm galvanised wire • Can tension up to 2mm stainless steel wire • Can tension up to 2.5mm aluminium wire • Stainless steel spring maintains a constant tension on the fence • Can be adjusted as required with the built-in ratchet • Used with DATS3 		<p>OMEGA WELDED BRACKETS</p> <ul style="list-style-type: none"> • Heavy duty welded brackets to secure the 2mm Omega posts onto the end and corner post • Available in three different lengths: 75mm (EY-OS/WS075AU), 112mm (EY-OS/WS112AU) and 180mm (EY-OS/WS180AU)

MODULUS SYSTEM

The patented Modulus brackets are designed with flexibility in mind. By using the different components, a full range of sizes and different applications can be formulated. It gives the installer flexibility on the spacing of the insulators, number of insulators and height of the fence. The key components are the two-way and three-way brackets. The two-way is primarily used as an intermediate bracket. The three-way is used as an end tensioning post, as a corner post, to change the wire direction, or as an inline strain post on long, straight walls.

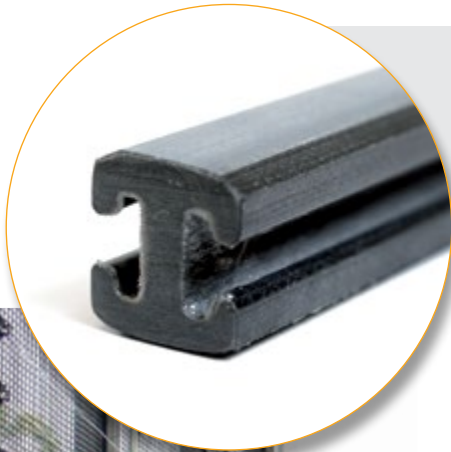

KEY FEATURES OF THE MODULUS SYSTEM

- Durable and can be installed in the most harsh environments
- Light to transport and easy to handle
- Insulators can be installed on both sides

MODULUS TWO-WAY BRACKET

- 2 660mm/27 wire (EMOD-2660C)
- 2 360mm/24 wire (EMOD-2360C)
- 1 960mm/20 wire (EMOD-1960C)
- 1 160mm/12 wire (EMOD-1160C)
- 960mm/10 wire (EMOD-960C)
- 460mm/5 wire (EMOD-460C)



MODULUS END CAP 19X19

(EMOD-BENDCAP)



MODULUS SLIDE INSULATOR

(EMOD-BSLD)



MODULUS MOUNTING BRACKET

Single hole (EMOD-BRKT)





MODULUS THREE-WAY BRACKET

- 2 660mm/27 wire (EMOD-3WS2660C)
- 2 360mm/24 wire (EMOD-3WS2360C)
- 1 960mm/20 wire (EMOD-3WS1960C)
- 1 160mm/12 wire (EMOD-3WS1160C)
- 960mm/10 wire (EMOD-3WS960C)
- 460mm/5 wire (EMOD-3WS460C)



MODULUS END THREE-WAY CAP 26X19

(EMOD-BENDCAP 3)



MODULUS SPACER

(EMOD-BSPR)



MODULUS HOOK

(ES-HK/MOD)



MODULUS BASE (EMOD-BB)

- Used to secure up to a six-wire Modulus bracket onto a wall
- Upright or at an angle as required



MODULUS BASE

(EMOD-BB)



FENCE WIRE, CABLE AND ACCESSORIES

FENCE WIRES



Nemtek offers a variety of wires to address different electric fencing requirements. The type of wire needed will depend on environmental factors, mechanical strength and electrical resistance.

Nemtek aluminium wire has the lowest resistance allowing long fences to be powered up, reducing the number of energizers needed. Nemtek stainless steel wire is recommended for corrosive and coastal environments. Nemtek galvanised wire offers good electrical conductivity and mechanical strength.

WIRE RANGE AND DESCRIPTION	WIRE DIAMETER	SPOOL SIZE	RESISTANCE OHMS/KM	CORROSION GUIDELINE*			
				INLAND	COASTAL	INDUSTRIAL	DISTANCE FROM THE COASTLINE
GALVANISED/GALFAN (XL)							
Stranded wire (EW-T12/BB)	1.2mm	680m	175	Yes			+50km
Stranded wire (EW-T12)	1.2mm	2 990m	175	Yes			+50km
Stranded wire (EW-T16)	1.6mm	1 560m	125	Yes			+50km
Stranded wire (EW-T16XL)	1.6mm	1 560m	125	Yes	Yes		+5km
Stranded wire (EW-T20)	2.0mm	1 000m	80	Yes			+50km
Stranded wire (EW-T20XL)	2.0mm	1 000m	80	Yes	Yes		+5km
Solid light galvanised (EW-G2.24)	2.24mm	1 650m	50	Yes			+50km
Solid heavy galvanised (EW-G2.00HG)	2.0mm	2 069m	63	Yes	Yes	Yes	+0.5km
Solid heavy galvanised (EW-G2.24HG)	2.24mm	1 650m	50	Yes	Yes	Yes	+0.5km
Solid galfan wire (EW-GN1.6/25KG)	1.6mm	1 582m	78	Yes	Yes	Yes	+0.1km
Solid galfan wire (EW-GN2.0/25KG)	2.0mm	1 012m	63	Yes	Yes	Yes	+0.1km
STAINLESS STEEL 304							
Stranded 304 (EW-TSS304/8)	1.2mm	800m	700	Yes			+50km
Stranded 304 (EW-TSS304/16)	1.2mm	1 600m	700	Yes			+50km
Solid wire 304 (EW-SS1/304)	1.0mm	1 985m	1 000	Yes			+50km
Solid wire 304 (EW-SS12/304/7)	1.2mm	770m	700	Yes			+50km
Solid wire 304 (EW-SS12/304)	1.2mm	1 375m	700	Yes			+50km
STAINLESS STEEL 316							
Stranded 316 (EW-TSS316)	1.2mm	800m	700	Yes	Yes	Yes	+0.1km
Solid wire 316 (EW-SS1/316)	1.0mm	1 985m	1 000	Yes	Yes	Yes	+0.1km
Solid wire 316 (EW-SS12/316/7)	1.2mm	770m	700	Yes	Yes	Yes	+0.1km
Solid wire 316 (EW-SS12/316)	1.2mm	1 375m	700	Yes	Yes	Yes	+0.1km
Solid wire 316 (EW-SS16/316)	1.6mm	770m	390	Yes	Yes	Yes	+0.1km
Solid wire 316 (EW-SS20/316)	2.0mm	495m	250	Yes	Yes	Yes	+0.1km
ALUMINIUM ALLOY WIRE							
Stranded wire (EW-AL16S/500)	1.6mm	500m	31	Yes	Yes		+5km
Stranded wire (EW-AL16S)	1.6mm	1 000m	31	Yes	Yes		+5km
Stranded wire (EW-AL20S)	2.0mm	1 000m	18	Yes	Yes		+5km
Solid wire (EW-AL16)	1.6mm	1 000m	27	Yes	Yes		+5km
Solid wire (EW-AL20)	2.0mm	1 000m	14	Yes	Yes		+5km
Solid wire (EW-AL20/1500)	2.0mm	1 500m	14	Yes	Yes		+5km
Solid wire (EW-AL25/1200)	2.5mm	1 200m	9	Yes	Yes		+5km

* This table serves as a guideline only. For more accurate information, please seek professional advice on the corrosion environment and local conditions.



HT CABLES

Nemtek offers a range of high-voltage cables (HT) to use with your energizer and for all other insulated high-voltage transmissions. The HT cables have been designed for a long life expectancy and are double insulated.

	<p>CABLES (S-SERIES)</p> <ul style="list-style-type: none"> • The S-Series HT cables can be used with all the Nemtek galvanised and stainless steel wires • Available in black 30m (EH-BS030S), 100m (EH-BS100S), 200m (EH-BS200S), 500m (EH-BS500S) and 1 000m (EH-BS1000S) spools • Available in white 30m (EH-WS030S), 100m (EH-WS100S) and 200m (EH-WS200S) spools • The multi-core S-Series makes the installation faster and neater • Available in black three-core 30m (EH-3BS030) and 100m spools (EH-3BS100); four-core 100m spools (EH-4BS100) and five-core 100m spools (EH-5BS100) • 30m multicore cables are suitable for Wizord 2i, Wizord 4i, Merlin 4i, Druid 13LCD, Druid 15LCD, Druid 18LCD, Druid 25LCD and Druid 28LCD energizers • 100m multicore cables are suitable for Wizord 2i, Wizord 4i, Merlin 4i, Druid 13LCD, Druid 15LCD and Druid 18LCD energizers • Max distance of multicore cables suitable for Merlin M18S and Merlin M28S is 15m
	<p>ALUMINIUM CABLE (A-SERIES)</p> <ul style="list-style-type: none"> • The A-Series HT cables can be used with all the Nemtek aluminium wires • Available in 1.6mm solid inner aluminium alloy conductor in 100m (EH-AS100), 200m (EH-AS200), 500m (EH-AS500) and 1 000m (EH-AS1000) spools • The multi-core A-Series makes the installation faster and neater • Available in black three-core 30m (EH-3AS030) and 100m (EH-3AS100) spools • 30m 3 core cables are suitable for Wizord 2i, Wizord 4i, Merlin 4i, Druid 13LCD, Druid 15LCD, Druid 18LCD, Druid 25LCD and Druid 28LCD energizers • 100m 3 core cables are suitable for Wizord 2i, Wizord 4i, Merlin 4i, Druid 13LCD, Druid 15LCD and Druid 18LCD energizers • Max distance of 3 core cables suitable for Merlin M18S and Merlin M28S is 15m
	<p>UNDERGATE CABLE (U-SERIES)</p> <ul style="list-style-type: none"> • The U-Series HT cable is used with both galvanised and aluminium wires • Available in 1.6mm heavy galvanised inner conductor; 25m (AH-UC1.6/25), 50m (AH-UC1.6/50) and 100m spools (AH-UC1.6/100) • Available in 2.5mm heavy galvanised inner conductor; 25m (AH-UC2.5/25), 50m (AH-UC2.5/50), 100m (AH-UC2.5/100), 200m (AH-UC2.5/200) and 500m (AH-UC2.5/500) spools
	<p>STAINLESS STEEL CABLE (SS-SERIES)</p> <ul style="list-style-type: none"> • The SS-Series HT cables can be used with all the Nemtek stainless steel wires – 316 • Available in black 100m spools (EH-BINOX100S)

WIRE TENSIONING SYSTEMS





WIRE TENSIONERS – PLASTIC

The Nemtek engineering plastic wire tensioners can be used with any type of fencing wire. The plastic material eliminates galvanic reaction between the tensioner and the wire which reduces rust.

	<p>COMPRESSION SPRING 1</p> <ul style="list-style-type: none"> • Black (ES-CNT) or white (ES-CNTW) • Can tension up to 1.2mm wire • Stainless steel spring maintains constant tension on the fence • Silver spring 	
	<p>COMPRESSION SPRING 2</p> <ul style="list-style-type: none"> • Black (ES-CNT2) or white (ES-CNT2W) • Can tension up to 1.6mm wire • Stainless steel spring maintains constant tension on the fence • Gold spring 	
	<p>HEAVY DUTY COMPRESSION SPRING 3 (ES-CNT3)</p> <ul style="list-style-type: none"> • Can tension up to 2mm wire • Stainless steel spring maintains constant tension on the fence • Silver spring 	
	<p>HYBRID COMPRESSION SPRING 1 (ES-CNTHB)</p> <ul style="list-style-type: none"> • Can tension up to 1.2mm wire • Combination of a compression spring and a ratchet tensioner • Silver spring 	
	<p>HYBRID COMPRESSION SPRING 2 (ES-CNT2HB)</p> <ul style="list-style-type: none"> • Can tension up to 1.2mm galvanised and stainless steel wire • Can tension up to 1.6mm aluminium wire • Combination of a compression spring and a ratchet tensioner • Gold spring • Used with the DATS2 	
	<p>HYBRID COMPRESSION SPRING 3 (ES-CNT3HB)</p> <ul style="list-style-type: none"> • Can tension up to 1.6mm galvanised and stainless steel wire • Can tension up to 2mm aluminium wire • Combination of a compression spring and a ratchet tensioner • Silver spring 	
	<p>HYBRID COMPRESSION SPRING 4 (ES-CNT4HB)</p> <ul style="list-style-type: none"> • Can tension up to 2.24mm galvanised wire • Can tension up to 2.0mm stainless steel wire • Can tension up to 2.5mm aluminium wire • Stainless steel spring maintains a constant tension on the fence • Can be adjusted as required with the built-in ratchet tensioner • Silver spring • Used with the DATS3 	
	<p>MINI NYLON TENSIONER (ES-DT/MN)</p> <ul style="list-style-type: none"> • Can tension up to 1.2mm galvanised and stainless steel wire • Can tension up to 1.6mm aluminium wire • Can be adjusted with a ratchet tensioner 	

	<p>HYBRID COMBO TENSIONER BB (ES-CTNTBB)</p> <ul style="list-style-type: none"> • Can tension up to 2.5mm steel wires • Engineered plastic material eliminates galvanic reaction between dissimilar metals, thus eliminating rust • Can be used with any type of wire • A hardy heavy duty tensioner for all weather types • Uses a ratchet tensioner to tension the fence 	
	<p>HYBRID COMBO TENSIONER BD BLACK (450KG) (AS-WSI/BD)</p> <ul style="list-style-type: none"> • Can tension steel wires up to 3.0mm • Can tension poly wires up to 3.5mm • Working force up to 450kg • A hardy heavy duty tensioner for all weather types • Engineered plastic material eliminates galvanic reaction between dissimilar metals, thus eliminating rust • Can be used with any type of wire • Effortless tensioning using a half-inch ratchet 	

WIRE TENSIONERS – METAL

	<p>COMBO TENSIONER – STANDARD (ES-CTS)</p> <ul style="list-style-type: none"> • Galvanised permanent fence wire tensioner with built-in insulator (plastic) • Can tension up to a 2.24mm wire • Only use with galvanised wires to avoid galvanic reaction 	
	<p>COMBO TENSIONER – PORCELAIN (ES-CTP)</p> <ul style="list-style-type: none"> • Galvanised permanent fence wire tensioner with built-in insulator (porcelain) • Can tension up to a 2.24mm wire • Only use with galvanised wires to avoid galvanic reaction • Used in areas where fire is a concern 	



TENSIONER AND INSULATOR HOOKS

	<p>MODULUS AND JURASSIC HOOK (ES-HK/MOD)</p> <ul style="list-style-type: none"> • Stainless steel hook for long life expectancy • Quick fit onto the Nemtek Modulus slide insulator and the Jurassic insulator 	
<p>Large tail hook</p>  <p>90° heavy duty large tail hook</p>	<p>LARGE TAIL HOOK (ES-H/LT)</p> <ul style="list-style-type: none"> • 2.0mm stainless steel hook for long life expectancy • Large tail to fit the Nemtek range of tensioning devices • Quick fit onto the Nemtek round and flat bar insulator • 2.5mm 90° heavy duty large tail hook available (ES-H/LT/2.5/90D) 	
	<p>S-HOOK (ES-HK/EP)</p> <ul style="list-style-type: none"> • Hot dip galvanised for long life expectancy • Heavy duty durable design • Suitable for angled and round corner poles 	
	<p>90 DEGREE S-HOOK (ES-HK/EP/90DEG)</p> <ul style="list-style-type: none"> • Hot dip galvanised for long life expectancy • Heavy duty durable design • Suitable for Omega brackets 	
	<p>180 DEGREE S-HOOK (ES-HK/EP/DS)</p> <ul style="list-style-type: none"> • Hot dip galvanised for long life expectancy • Heavy duty durable design • Suitable for Omega brackets 	
	<p>THROUGH HOLE S-HOOK (ES-HK/THR/HDG)</p> <ul style="list-style-type: none"> • Hot dip galvanised for long life expectancy • Heavy duty durable design • Easy to install 	
	<p>U-HOOK (ES-HK/UH304)</p> <ul style="list-style-type: none"> • Stainless steel hook for long life expectancy • Heavy duty durable design • Easy to install 	

WIRE AND CABLE CONNECTORS

	<p>BOLT-TYPE LINE CLAMP</p> <ul style="list-style-type: none"> • 6mm – XL galvanised (EA-LC6) or stainless steel (EA-LC6/SS) • 8mm – XL galvanised (incl wave washer) (EA-LC8/D) • 6mm line clamp is used for 1.6mm wires • 8mm line clamp is used for up to 2.0mm wires 	
	<p>U-TYPE LINE CLAMP (EA-LC8/MG)</p> <ul style="list-style-type: none"> • 8mm XL galvanised • Used for wires up to 2.24mm • Can be connected after the wire has been installed 	
	<p>CLAW-TYPE LINE CLAMP (EA-LC8/C)</p> <ul style="list-style-type: none"> • Can be utilised to change direction of wire • XL galvanised • Used for solid wires up to 3.0mm 	
	<p>ALUMINIUM FERRULE</p> <ul style="list-style-type: none"> • 6mm (EA-F6AFT) used with 1.6mm aluminium wire • 10mm (EA-F10AFT) used with 2.0mm and 2.5mm aluminium wire <p>TINNED COPPER FERRULE</p> <ul style="list-style-type: none"> • 6mm (EA-F6S) used with 1.2mm galvanised wire • 10mm (EA-F10) used with 1.6mm and 2.0mm galvanised wire • 16mm (EA-F16) used with 2.24mm galvanised wire <p>STAINLESS STEEL FERRULE</p> <ul style="list-style-type: none"> • 6mm (EA-F6S/SS) used with 1.0mm and 1.2mm stainless steel wire • 10mm (EA-F10S/SS) used with 1.6mm and 2.0mm stainless steel wire 	
	<p>BRIDGING WIRES</p> <ul style="list-style-type: none"> • Reduces installation time, with an aesthetic and neat finish • Available in galvanised long extra secure 200mm (EA-BW1.8X200HDL) • Available in galvanised finish 100mm (EA-BW/1.8x100HD) and 200mm (EA-BW/1.8x200HD) • Available in stainless steel finish 100mm (EA-BW/1.6x100SS) and 200mm (EA-BW/1.6x200SS) 	

WIRE DISPENSERS



LARGE WIRE DISPENSER

(EW-JENNY)

- Portable design
- From 2.0mm up to 3.0mm wire
- Dispenses rolls of up to 50kg







BRAIDED WIRE REEL HOLDER

(EW-T/RH)













- Used with most of the Nemtek wires and tapes that are on spools
- Portable robust design

INSULATORS

PORCELAIN INSULATORS

	<p>PORCELAIN BOBBIN INSULATOR (EI-BPFL, EI-BPFL10)</p> <ul style="list-style-type: none"> • Fireproof and long lasting • Large design to reduce power loss and arcing • Suitable for long runs and can withstand high tension 	
	<p>PORCELAIN STRAIN INSULATOR (EI-STFP, EI-STFP10)</p> <ul style="list-style-type: none"> • Fireproof and long lasting • Large design to reduce power loss and arcing • Suitable for long runs and can withstand high tension 	

PLASTIC INSULATORS

	<p>ROUND BAR INSULATOR</p> <ul style="list-style-type: none"> • Black (EI-BRBB) and white (EI-BRBW) • Used with the 10mm round bar • Flexible inner core for increased clearance • Quick fit design clip – easy to replace when required 	
	<p>FLAT BAR INSULATOR</p> <ul style="list-style-type: none"> • Black (EI-BFBB) and white (EI-BFBW) • Quick fit design clip – easy to replace when required • Feed through or clip option built in 	
	<p>NAIL-ON INSULATOR</p> <ul style="list-style-type: none"> • Black (EI-NOB) and white (EI-NOW) • Large clips for heavy duty applications with thicker wires • Larger clearance to eliminate power leakage 	
	<p>Y-STANDARD INSULATOR</p> <ul style="list-style-type: none"> • Black (EI-YB) and white (EI-YW) • Quick fit design – easy to replace when required • Suitable for Y-standard brackets 	
	<p>OMEGA INSULATOR</p> <ul style="list-style-type: none"> • Black (EI-OB) • Double-tracking fin to reduce tracking and arcing • Quick fit design for the Omega bracket • Anti-climb version available (EI-OB/C) 	
	<p>OMEGA PULL THROUGH INSULATOR</p> <ul style="list-style-type: none"> • Black (EI-BTL2) • Reduces installation time • Double shield with large tracking distance • Heavy duty and durable design • Large clearance distance to reduce power loss and arcing 	

	<p>POP THROUGH HOLE INSULATOR</p> <ul style="list-style-type: none"> • Black (EI-POPEM(B\ULT)) and white (EI-POPEM(W\ULT)) • Feed through clip option built in for higher security • Larger tracking distance to reduce power loss and arcing 	
	<p>JUMBO STRAIN INSULATOR</p> <ul style="list-style-type: none"> • Black (EI-STB/J) and white (EI-STW/J) • Suitable for fences using up to 2.0mm wire • Larger clearance distance to reduce power loss and arcing • Suitable for low- to medium-tensioned fences 	
	<p>ULTRA STRAIN INSULATOR</p> <ul style="list-style-type: none"> • Black (EI-STB/R) and white (EI-STW/R) • Suitable for fences using up to 2.0mm wire • Larger clearance distance to reduce power loss and arcing • Suitable for medium-tensioned fences 	
	<p>ULTRA HARDENED STRAIN INSULATOR</p> <ul style="list-style-type: none"> • Black (EI-STB/R/H) and white (EI-STW/R/H) • Suitable for fences using up to 3.0mm wire • Suitable for high-tensioned fences 	
	<p>PICKET INSULATOR</p> <ul style="list-style-type: none"> • Black (EI-PI) • Used with Nemtek Y-picket post • Double tracking shield to reduce tracking and arcing • Quick fit design clip – easy to replace when required 	
	<p>JURASSIC INSULATOR – SLOTTED</p> <ul style="list-style-type: none"> • Black (EI-JIB6.20/S) and white (EI-JIW6.20/S) • Wire slot for quick installation • Larger clearance distance to reduce power loss and arcing 	
	<p>JURASSIC INSULATOR – THREAD THROUGH</p> <ul style="list-style-type: none"> • Black (EI-JIB6.20) and white (EI-JIW6.20) • For high security • Larger clearance distance to reduce power loss and arcing 	
	<p>SHIELD INSULATOR</p> <ul style="list-style-type: none"> • Black (EI-SI) • Larger clearance distance to reduce power loss and arcing • Feed through and slotted for maximum security or quicker wire placement 	
	<p>SELF TAPPER HOOK (EA-JSTH)</p> <ul style="list-style-type: none"> • Used with the Shield and Jurassic insulators • Available in a long version (EA-JSTH/L) 	

GENERAL ACCESSORIES

FENCE ACCESSORIES







		
<p>WARNING SIGNS (EA-WRS2/N)</p> <ul style="list-style-type: none"> • Custom-made warning signs are available to order • Wire clips on the warning sign reduce installation time 	<p>TIMED FENCE LIGHT</p> <ul style="list-style-type: none"> • The frequency of the flashing LEDs indicates the voltage level on the fence. The longer the period between flashes, the lower the voltage on the fence • Grey fence light for galvanised and aluminium wire (inland use) (SR-FL/TL/G) • Blue fence light for stainless steel wire (coastal use) (SR-FL/TL/SS) 	<p>CUT-OUT SWITCH (AA-COS)</p> <ul style="list-style-type: none"> • Isolates a section of the fence to allow for easy maintenance and fault finding • Large design suitable for game farm applications
		
<p>STROBE LIGHT</p> <ul style="list-style-type: none"> • Strobe light (12VDC) • Waterproof (IP67) • Green (SR-STRG) and red (SR-STRR) 	<p>DOUBLE POLE LIGHTNING PROTECTION (EA-LIDII)</p> <ul style="list-style-type: none"> • Lightning-protection system inhibits lightning and diverts the voltage spikes caused by lightning • Stainless steel components for long life 	<p>TAG (EE-WIZ4/MAGNET)</p> <ul style="list-style-type: none"> • Fits onto a key ring • Most Nemtek energizers can be switched on and off, or reset using the Nemtek tag
		
<p>STATUS INDICATOR (SR-SL)</p> <ul style="list-style-type: none"> • Red, green and blue LEDs (12VDC) 	<p>SIREN 15 WATT</p> <ul style="list-style-type: none"> • 15 Watt dual-tone siren (12VDC) (SR-10) • 15 Watt 6-tone siren (12VDC) (SR-6T) 	<p>SIREN 30 WATT (SR-30)</p> <ul style="list-style-type: none"> • 30 Watt dual-tone siren (12VDC)

EARTH SPIKES

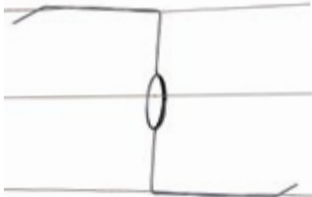
				
1M HOT DIP GALVANISED [EA-EAG1]	1.2M HOT DIP GALVANISED [EA-EAG12]	1M COPPER-CLAD [EA-EAN]	1.2M COPPER-CLAD [EA-EAN/L]	EARTH SPIKE LUG [EA-LEAN] *use with copper-clad earth spikes only
<ul style="list-style-type: none"> • Hot dip galvanised or copper-clad earth spikes with nuts and washers • The double nut and washer allow for a good electrical connection with the HT cables • Conductive earthing compound available to enhance earthing conditions (EA-CEC) 				

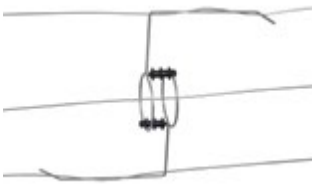
EARTH LOOPS

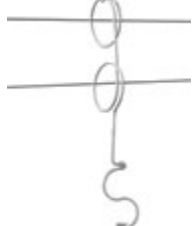
Earth loops are used to enhance the level of security offered by an electric fence by detecting attempted separation of fence wires and leaving just enough room for natural movement of the live wire. When a wire touches the loop, a connection or short is made and the alarm will sound.







	IN-LINE LOOP <ul style="list-style-type: none"> • Installed onto the fence wire, generally on the earth wires • Available in galvanised finish (EY-1LOOP) • Available in stainless steel (EY-1LOOP/SS) 	
	EARTH LIVE LOOP (EY-1LOOP/EL) <ul style="list-style-type: none"> • Installed onto the fence wire, generally on the live wires • Available in galvanised finish 	
	WALL-MOUNTED EARTH LOOPS <ul style="list-style-type: none"> • Installed onto the wall protecting the bottom wires on a wall top fence • They offer protection against lifting of the fence wires • Available in stainless steel, angled or straight depending on the type of Nemtek bracket used • Angled (EA-WML/A) • Straight (EA-WML/S) 	
	GROUND ANTI-CREEP LOOP (EY-ANTICREAP) <ul style="list-style-type: none"> • Used in the freestanding applications to reduce the possibility of lifting of the bottom fence wires • Concreted for maximum stability • Hot dip galvanised finish for a long life 	

GATE SYSTEMS

The Nemtek gate contacts have a robust construction and use stainless steel and brass metal components, making it suitable for most environmental conditions.

			
<p>GATE LOCATOR AND SWING GATE PLATES (EY-GLAU, EY-GPAU)</p> <ul style="list-style-type: none"> • Heavy duty design • Electro plated • For both the 2-way and the 3-way gate contacts 	<p>2-WAY GATE CONTACT (EA-SGC07, EA-SGC13)</p> <ul style="list-style-type: none"> • Used for series wiring of a gate • Suitable for sliding gates • Lug or brass connectors • Available with earth plate (EA-SGC13/EARTH) 	<p>3-WAY GATE CONTACT (EA-SGC193W)</p> <ul style="list-style-type: none"> • Effective short to earth detection over sliding gates • 2 live and 1 earth connectors with lugs • Available with brass connectors (EA-SGC213W) 	<p>GATE MOUNTING BRACKET (EA-SGC/UNIB)</p> <ul style="list-style-type: none"> • Heavy duty design • Hot dip galvanised • For both the 2-way and the 3-way gate contacts

FENCING TOOLS

		
<p>HEAVY DUTY DIAGONAL SIDE CUTTER PLIERS (TL-MNHW)</p> <ul style="list-style-type: none"> • Designed for high-tensile wire cutting up to 3.5mm wire 	<p>DISTANCE MEASURING WHEEL (TL-DMW)</p> <ul style="list-style-type: none"> • Quick, walk along distance-measuring tool 	<p>KNIPEX WIRE CUTTER (TL-MN)</p> <ul style="list-style-type: none"> • Designed for high-tensile wire cutting up to 2.5mm wire
		
<p>PROFESSIONAL CRIMPING TOOL (TL-CRP)</p> <ul style="list-style-type: none"> • Durable ferrule crimping tool 	<p>HALF INCH RATCHET TENSIONER (TL-RAT1/2)</p> <ul style="list-style-type: none"> • Used to tension the Hybrid combo tensioners 	<p>Y-PICKET POST DRIVER (TL-PDY)</p> <ul style="list-style-type: none"> • Used as a hammer to drive Y-pickets into the ground

SOLAR POWER

SOLAR PANELS

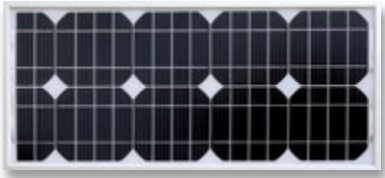

Nemtek solar panels offer a reliable source of power for electric fence systems in remote areas or where AC power supply is unreliable.

	45W	90W	140W
	SOL-SYS45W	SOL-SYS90W	SOL-SYS140W
Open-circuit voltage (Voc)	23.2V	23.2V	23.2V
Weight	3.8kg	7.1kg	10.6kg
Dimensions (L x W x H in mm)	610 x 456 x 30	740 x 670 x 35	1 095 x 670 x 35

SOLAR REGULATOR (SOL-REG140)



The LED solar regulator offers advanced Maximum Power Point (MPP) technology for over 90% efficiency when used with a 140Watt solar panel. It can also be used with solar panels ranging from 20Watt to 200Watt making it very flexible. Solar panels larger than 140Watt can be used in areas where sunlight intensity is low to increase the capture of sunlight.

- Power-handling capability 140W
- Solar panel input range 20W ~ 200W
- Maximum load supply current 10A
- The LED display indicates solar charge, battery condition and load indication
- Set to operate as a 12VDC system
- The regulator is equipped with various devices to protect its electronics
- Battery charge voltage Flooded, AGM, Gel lead-acid battery types

MOUNTING BRACKET (SY-SYZ040R)



SOLAR PANEL MOUNTING BRACKET

- Quick and easy to install onto most of Nemtek's solar panels
- Adjustable angle: 15, 30 and 45 degrees
- Use on panel: 20W, 45W, 90W and 140W
- Made from extruded aluminium with stainless steel fasteners



BATTERIES AND BATTERY BOXES

BATTERIES



Battery characteristics	7Ah	12Ah	28Ah	50Ah	100Ah
	BAT-B07	BAT-B12	BAT-B28	BAT-B50	BAT-B100
Nominal voltage	12V	12V	12V	12V	12V
Type	Sealed rechargeable battery				
Weight	2.15kg	3.4kg	9kg	16kg	29.8kg
Dimensions (L x W x H in mm)	151 x 65 x 95	151 x 99 x 101	175 x 165 x 126	229 x 138 x 213	329 x 172 x 218

Battery characteristics	7Ah	20Ah	30Ah	100Ah
	BAT-LIFE07	BAT-LIFE20	BAT-LIFE30	BAT-LIFE100
Nominal voltage	12.8V	12.8V	12.8V	12.8V
Type	LiFePo4 (Lithium battery)			
Weight	1kg	2.7kg	3.5kg	11.5kg
Dimensions (L x W x H in mm)	151 x 65 x 95	181 x 77 x 167	181 x 77 x 170	260 x 168 x 215

BATTERY BOXES



BATTERY BOX 50Ah (BAT-B50/BOX)

- Battery box with a 50Ah battery will allow you to have portable 12V power for a range of outdoor uses
- Outdoor protection for the 50Ah battery
- Strong and sturdy design
- 280mm (L) x 190mm (W) x 240mm (H)
- UV stabilised for long life







BATTERY BOX 100Ah (BAT-B100/BOX)

- Battery box with a 100Ah battery will allow you to have portable 12V power for a range of outdoor uses
- Outdoor protection for the 100Ah battery
- Strong and sturdy design
- 410mm (L) x 238mm (W) x 263mm (H)
- UV stabilised for long life



ENERGIZER ENCLOSURES

		
<p>SMALL ALUMINIUM BOX (ENC-ALU/S)</p> <ul style="list-style-type: none"> • Internal dimensions: 450(w) x 610(h) x 260(d)mm • External dimensions: 450(w) x 640(h) x 310(d)mm • Medium capacity to house an energizer, solar regulator and a deep cycle battery • Ventilated aluminium box 	<p>LARGE ALUMINIUM BOX (ENC-ALU)</p> <ul style="list-style-type: none"> • Internal dimensions: 800(w) x 610(h) x 300(d)mm • External dimensions: 800(w) x 640(h) x 350(d)mm • Ventilated aluminium box • Large capacity to house double energizers, solar regulator and deep cycle batteries • Available in shock box version (ENC-SHBOX) 	<p>XL ALUMINIUM BOX (ENC-ALU/XL)</p> <ul style="list-style-type: none"> • Internal dimensions: 800(w) x 760(h) x 300(d)mm • External dimensions: 800(w) x 790(h) x 350(d)mm • Ventilated aluminium box • Large capacity to house double energizers, solar regulator and deep cycle batteries

	<p>ENCLOSURE STANDS</p> <ul style="list-style-type: none"> • Hot-dip galvanised stands for the aluminium enclosures • Optional U-bracket (ENC-KDS/UBOLT) is required when creating a concrete base • Stands 1 180mm high off the ground • Available in two sizes. Small enclosure stand (ENC-KDS/S) and a larger enclosure stand (ENC-KDS) 	
	<p>ENCLOSURE STAND U-BRACKET (ENC-KDS/UBOLT)</p> <ul style="list-style-type: none"> • Use with concrete to secure the enclosure stand into the ground 	

	<p>BUSBAR INSULATOR (EI-SBI)</p> <ul style="list-style-type: none"> • Suitable for electrically separating two steel items • Used with a shock box
-------------------------------------------------------------------------------------	-----------------------------------------------------------------------------------------------------------------------------------------------------------------------------------



		
<p>FIBREGLASS ENCLOSURE (ENC-EMB-A)</p> <ul style="list-style-type: none"> • (h) 305 x (w) 305 x (d) 155mm • Ideal for outdoor use • Ideal for general use 	<p>FIBREGLASS ENCLOSURE (ENC-RL6D-P)</p> <ul style="list-style-type: none"> • (h) 450 x (w) 300 x (d) 210mm • Ideal for outdoor use • Ideal for smaller energizers 	<p>FIBREGLASS ENCLOSURE (ENC-AP3-A)</p> <ul style="list-style-type: none"> • (h) 620 x (w) 470 x (d) 265mm • Ideal for outdoor use • Ideal for larger energizers
		
<p>METAL ENCLOSURE (ENC-SB/WIZ)</p> <ul style="list-style-type: none"> • (h) 460 x (w) 305 x (d) 230mm • Powder coated steel enclosure for indoor and inland use • Display window for easy viewing • Lockable with a padlock • Ideal for the smaller range of energizers 	<p>METAL ENCLOSURE (ENC-SB/STEALTH)</p> <ul style="list-style-type: none"> • (h) 610 x (w) 460 x (d) 230mm • Powder coated steel enclosure for indoor and inland use • Display window for easy viewing • Lockable with a padlock • Ideal for the larger range of energizers 	<p>GENERAL PURPOSE ENCLOSURES</p> <ul style="list-style-type: none"> • Mini (h) 100 x (w) 100 x (d) 50mm (ENC-C51) • Small (h) 150 x (w) 110 x (d) 70mm (ENC-C52) • Medium (h) 190 x (w) 140 x (d) 70mm (ENC-C53) • Large (h) 305 x (w) 205 x (d) 110mm (ENC-C54)

ELECTRIC FENCE COMPONENT CHECKLIST

ENERGIZERS	
Single zone energizers	Wizord: 2i, 4i Merlin: 4i and Merlin Stealth: M18S Druid: 13LCD, 15LCD, 18LCD
Dual zone energizers	Merlin Stealth: M28X Druid: 25LCD, 28LCD
Four zone systems	Use two Druid 25LCD or 28LCD energizers and one four zone keypad
Multi zone systems	Druid FG system Druid Fence Probe software with FG7C
Multi zone communication	Fibre optic: single mode, multi-mode Wireless: Microwave RS485
Synchronisation module	For the Druid 25LCD/28LCD energizers
Druid relay expansion card	Druid 25LCD/28LCD energizer relay expansion card
Keypads	Merlin and Druid range
FENCE MONITOR	
Dual zone fence monitor	Druid 20LCD Fence Monitor
FENCING POSTS AND BRACKETS	
Wall top brackets	Round bar, flat bar, square tubing-pole, profile poles, T-pole Stays and stay sleeves for corners Lugs and rubber clamps for the stays
Freestanding fencing posts	Nemtek Y-pickets Corner poles and stays Insulators: Picket, pop through, strain
Omega brackets	1mm bracket intermediate 2mm bracket, corner and end post Omega mounting brackets: plastic spacer and welded brackets Insulators: Omega double shield Pull through assembly with insulator
Modulus brackets	Two-way and three-way Modulus insulators: slide and spacer Mounting bracket
Bracket fasteners	Nail-in anchors, hammer drives, tek screws, coach screws
FENCE WIRES AND CABLES	
Fence wires	Galvanised, stainless steel, aluminium. Solid or stranded
Cables (HT Cables)	A-series, U-series, S-series (single- and multi-core) and SS-series Communication cables for sirens and keypads
WIRE TENSIONING SYSTEMS AND CONNECTORS	
Tensioners	Spring tensioners Ratchet tensioners Spring tensioners with built-in ratchet (Hybrid)
Hooks	Large tail, Modulus and Jurassic, S-hook, through hole S-hook, U-hook, 90 degree hook and 180 degree hook
Bridging wires	100mm and 200mm bridging wires available in stainless steel and hot dip galvanised
Wire and cable connectors	Line clamp: Bolt type, U-type and Claw-type Ferrules: stainless steel, aluminum, tinned copper

INSULATORS	
Plastic	Round bar, flat bar, nail-on, Y-standard, Omega, Omega-pull through, pop through hole, strain, picket, Jurassic, Shield and tension bobbin
Porcelain	Bobbin, strain and busbar
Tension Sensors	DATS2 and DATS3, Tension Sensor System
GENERAL ACCESSORIES	
Warning signs	Required every 10m, direction change and on each gate. Custom warning signs available
Fence light	High-voltage fence-timed light indicator
Cut-out switch	High-voltage cut-out switch
Lightning protection	Double pole lightning protection
Siren and strobe lights	Sirens 15 Watt (single or 6-tone) or 30 Watt. Strobe light (red or green)
Earth and live loops	Wall mount, in-line, anti-creap
Earth spikes	Copper clad and galvanised, 1m and 1.2m
Gate contacts and gate mounting bracket	Two-way and three-way sliding gate contacts with earth plate (alarm when open). Mounting bracket
Conduit and accessories	20mm and 25mm
ENCLOSURES	
Energizer enclosures	Powder coated steel with window (indoor and inland use) Aluminium enclosure Fibre glass enclosure
Shock box enclosure	Aluminium available in small, large and extra large
Freestanding enclosure stand	U-bolt to secure stand in concrete
General purpose enclosures	Plastic available in mini, small, medium, and large types
SOLAR POWER	
Solar panels and mounting brackets	45 Watt, 90 Watt and 140 Watt solar panels. Pole mount and mounting brackets
Solar regulators	12V 10Ah LED regulator
Deep cycle batteries	50Ah and 100Ah
TOOLS AND TESTERS	
Fence scope multi-tool and pouch	Four-in-one (directional fault finder, joule meter, scope and noise meter). Handy tool pouch
Fence meter	Digital fence meter used to easily diagnose fence problems to optimise the installation and ensure the fence operates at an ideal level
Easy fence tester	Clipped onto the fence for easy testing and shows the high and low voltage condition of the fence
Crimping tool	For the 6mm, 10mm and 16mm ferrules
Ratchet tool	Used with the combo hybrid tensioners
Wire dispensers	Reel or coil dispenser
Wire cutters	Heavy duty, Knipex cutter
Drill bits	Steel and masonry drill bits. SDS masonry drill bits
Y-picket driver tool	For the Nemtek Y-pickets
Distance-measuring wheel	Site measurement in metres



DANGER
ELECTRIC FENCE

SUPPLIED BY
NEMTEK
ELECTRIC FENCING PRODUCTS
www.nemtek.com

TIPS TO INCREASE YOUR SECURITY

Nemtek's world-class products are designed and manufactured to ensure a high-security solution and offer reliability for many years. Due to the large range of products on offer, here are a few tips to ensure your system meets your security needs and operates reliably:

- Spacing between fence wires must not exceed 100mm. This will reduce attempts to part wires. Earth or live loops fitted on the fence will cause an alarm when there is an attempt to part the wire.
- The bottom fence wire, where possible, should be live and fitted with an anti-creep loop where there is a threat of lifting. The top wire must also be live.
- All electric fencing live wires must be connected in a series circuit so that a cut live wire can be detected anywhere along the fence.
- Spacing between posts must not exceed 3 metres. This will discourage attempts to part wires. In the case of freestanding fencing it is recommended that a shorter post be placed between the main posts reducing the span to 1.5m. This in-between shorter post will stop any attempts to lift the bottom wires. Ensure that the ground under the freestanding fencing is secure and not easy to dig under. The height of the freestanding fence must be at least 2m.
- The height of the bracket above the wall is important; the higher the wall brackets the more it discourages attempts to step over the fence. The wider walls will need higher and angled brackets to cover the span of the wall top and reduce any chance of standing on the wall.
- The fence wires must be under constant tension using compression springs. This will improve the aesthetics and the security of the fence.
- Installing tension-sensing devices increases the likelihood of an intruder being detected and reduces the possibility of tampering by the lifting and parting of the wires.
- Alarm zone lengths should not be longer than 200 metres. The zones should be powered by an energizer with independently monitored zones. This will help locate a fault more quickly. This is not always possible due to cost and location constraints. In high-security areas shorter zones are recommended.
- No two zones must rely on each other being intact to operate effectively and must be independently alarm-monitored. This is important in the case of an attempted multi-point entry breach of the fence.
- Gates can be a weak point. Make sure that sliding gates cannot be lifted up off the rack and be slid open. In the case of swing gates, they can be forced open when they are closed. These gates can be monitored for unauthorised entry using a magnetic switch.
- Ensure that the fence is kept free of vegetation.

Frequent testing of the fence is imperative. A few points along the fence line must be tested.

NEMTEK

Electric Fencing Products



SOUTH AFRICA

Head Office, Exports and Training Academy

websales@nemtek.com

+27 (0)11 462 8283/4

Stand 206 Boundary Park, Cnr Malibongwe and Epsom Avenue,
Northriding, Randburg, South Africa

Bloemfontein

+27 (0)54 332 1338

Plot 42 Gemsbok Street, Unit 12, Quaggafontein, Bloemfontein,
South Africa

Cape Town

+27 (0)21 386 3742/3100

21 Concord Crescent, Airport City, Cape Town, South Africa

Edenvale

+27 (0)11 453 1970

Units 1 & 2, Eden Crossing, Cnr Dick Kemp and Herman Street,
Edenvale, South Africa

KwaZulu-Natal

+27 (0)31 701 2125

19 Henwood Road, Pinetown, South Africa

Nelspruit

+27 (0)13 752 2187

46 Rapid Road, Riverside Industrial Park, Nelspruit, South Africa

Port Elizabeth

+27 (0)41 581 4130

Unit 4, 51 Leadwood Crescent, Fairview, Port Elizabeth, South Africa

AUSTRALIA

+61 8 9303 9855

Unit 5, 19 Innovation Circuit, Wangara, 6065, Perth, WA, Australia

EUROPE

+31 88 27 60 910

Sprendlingenstraat 18k, 5061KN Oisterwijk, The Netherlands

www.nemtek.com